



MAIN MENU

CONTENTS

Product finder/Index 3

Informations 4

Floor sockets/Box systems indoor 5-29

Floor sockets outdoor 30-37

Hollow space floor box systems 38-46

Underfloor Systems 47-50

CEE-floor sockets 51-56

Retractable power distributor 57-60

Energy columns 61-67

Wall distributors 68-74

E-Mobility 75-77

Desk power strip 78-80

Hanging distributors 81-83

General terms and conditions 84-87

Model withdrawal form 88



INDEX

1206	6	7702A.....	34	9902D.....	28
12201	25	7704A	35	9904A	29
12251	35	7705A.....	55	9904AK.....	49
12252	36	8302A	13	9908A.....	45
12255	36	8308A	14	9908AK.....	50
12256	37	8310A.....	56	9912A.....	45
2003A	6	8314A.....	56	9912T	46
2003B	7	8501B.....	39	BAES32	67
2003Q	7	8501E.....	39	ES301	62
2004A	8	8502B.....	40	ES321.....	62
2004B	8	8502E.....	40	ES323	63
2004Q	9	8504B	41	ES323-EM	77
2008A	9	8504E.....	41	ES325	63
2008B	10	8508B	42	ES401	65
2008Q	10	8508BK.....	48	ES850	66
3202E.....	11	8508E.....	42	ESP14	64
3203E.....	11	8512B.....	43	ESP24	64
3301E.....	12	8512BK	48	ESP24-EM	77
3302E.....	12	8601A.....	14	EST24	65
3303E.....	13	8602A	15	HV1006	82
3202E.....	79	8604A	15	OCRH2W.....	80
3203E.....	79	8701A.....	16	OCRH6W.....	80
5501A.....	69	8702A.....	16	OT60A1	66
5503A.....	69	8802A	17	SV111	58
5510E	70	8802B	17	SV112.....	58
5511A	70	8802E.....	18	SV301	59
5523A.....	71	8802T.....	18	SV302.....	59
5602E.....	71	8804B	19	SV501	60
5606E.....	72	8804E.....	19		
5620E.....	72	8804T.....	20		
5622E.....	73	8808A	20		
5722E.....	73	8808B	21		
5723E.....	74	8808E.....	21		
5802A	76	8808T.....	22		
5802E.....	76	8810B.....	22		
6400E.....	52	8900B	23		
6522A	52	8901B.....	23		
6523Q	53	8902B.....	24		
6610A.....	53	8902H	43		
7003A.....	31	8904B	24		
7012A.....	54	8904H	44		
7012A63.....	54	8908B	25		
7022A	55	8908H	44		
7501A.....	31	8912B.....	26		
7601A	32	8912BK	49		
7602A.....	32	8920B	26		
7604A.....	33	9901A.....	27		
7701E	33	9902A	27		
7701M	34	9902B.....	28		

WE INTRODUCE OURSELVES

Since the company was founded in 2005, we develop and sell floor sockets, retractable supply posts, wall distributors and energy columns for indoor and outdoor use. The priorities are in quality, design and the best price-performance ratio.

In addition to our extensive standard program, we also offer individual processing and custom-made products. Our diverse range of services ensures that your requirements are implemented quickly and efficiently.

The fact that our products are made and manufactured exclusively in Germany can be seen from the elegant design, the high-quality material and the sophisticated workmanship. Robust, tough and weatherproof for outdoors, or discreet and adapted for indoors, our products are always practical and useful.

We only use VDE-certified socket inserts for our products, which you can also obtain from us according to French, Danish, Belgian or Swiss standards.

WITH US, YOU WILL BENEFIT

- With only one order number: One order number for a complete product.
- With ready-to-install products: You receive completely ready-to-install products, whereby the individual parts do not first have to be put together and laboriously assembled.
- With extensive stock goods: Many of our products are already prefabricated and can be delivered within a very short time.
- With a short response time: Ordered goods usually leave the factory on the same day, so that a large part of our deliveries arrive the next day.
- With creative special solutions: you can't find a suitable product that exactly matches your ideas? Let us know your requirements and we will develop affordable special solutions exactly according to your wishes.

CONTACT

BS Bodentsteckdosen Systemtechnik GmbH
Dingerdisser Str. 36
D-33699 Bielefeld
Tel. 0521 9892780 (Zentrale)
Fax 0521 989278-30
info@bodensteckdosen.com
bodensteckdosen.com

NOTE ON THE CONTENT OF THE CATALOG

The IP protection class applies to all products when closed and when installed correctly. Subeacht to errors and technical changes.

The illustrations in the catalog were created graphically. The equipment shown in the pictures is similar to the written description.

← Main menu



Floor sockets/Box systems
→ Indoor



1206

Item No: 1206	Equipment: 4 x Schuko, 2 x RJ45 double
Material: Solid aluminum housing	
Dimensions: 125x125x80 mm	
Instl dim: 125x125x80 mm	
Protection: IP20	
Load: Area load max. 120kg	
Supply line: Via opening from below	
Feature:	The on-floor tank is versatile, can also be mounted on work surfaces and under cupboards/shelves.



2003A

Item No: 2003A 2003A1	Equipment: 3 x Schuko 2 x Schuko, 1 x RJ45 double
Material: Stainless steel (1.4301), Aluminum	
Dimensions: 200 x 203 x 92 mm	
Instl dim: 200 x 203 x 92 mm	
Protection: IP65	
Load: Area load max. 900 kg	
Supply line: 2x back, each Ø 25 mm	
Feature:	Lockable with tools.

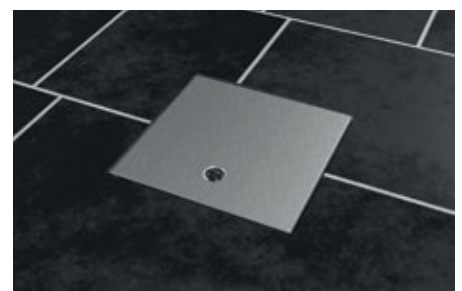



2003B

Item No.:	Equipment:
2003B	3x Schuko
2003B1	2x Schuko, 1x RJ45 double

Material:	Stainless steel (1.4301), Aluminum
Dimensions:	200 x 200 x 102 mm
Instl dim:	200 x 200 x 102 mm
Protection:	IP54
Load:	Area load max. 200 kg
Supply line:	2x back, each Ø 25 mm
Feature:	Lockable without tools, flooring can be integrated.

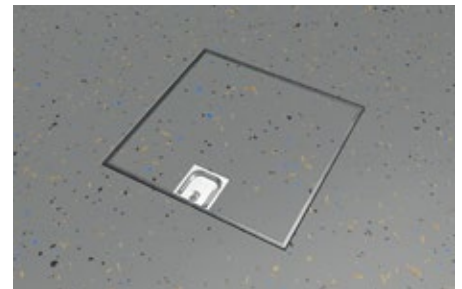

2003Q

Item No.:	Equipment:
2003Q	3x Schuko
2003Q1	2x Schuko, 1x RJ45 double

Optional parts:	
OT60A1	Connection pillar (page 67)

Material:	Stainless steel (1.4301), Aluminum, PVC
Dimensions:	200 x 203 x 92 mm
Instl dim:	200 x 203 x 92 mm
Protection:	IP54/IP21 mit aufgestecktem Tubus
Load:	Area load max. 900 kg
Supply line:	2x back, each Ø 25 mm
Feature:	Lockable with a tool, with internal tube for using the tank with the lid closed.

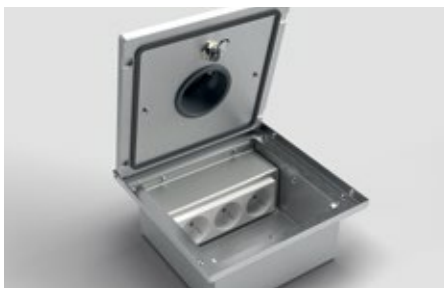



2004A

Item No.:	Equipment:
2004A	4 x Schuko
2004A1	3 x Schuko, 1 x RJ45 double

Material:	Stainless steel (1.4301), Aluminum
Dimensions:	250 x 253 x 92 mm
Instl dim:	250 x 253 x 92 mm
Protection:	IP54
Load:	Area load max. 900 kg
Supply line:	4x back, each Ø 25 mm
Feature:	Lockable with a tool.



2004B

Item No.:	Equipment:
2004B	4 x Schuko
2004B1	3 x Schuko, 1 x RJ45 double

Material:	Stainless steel (1.4301), Aluminum
Dimensions:	250 x 250 x 102 mm
Instl dim:	250 x 250 x 102 mm
Protection:	IP54
Load:	Area load max. 200 kg
Supply line:	4x back, each Ø 25 mm
Feature:	Lockable without tools, flooring can be integrated.





2004Q

Item No.:	Equipment:
2004Q	4 x Schuko
2004Q1	3 x Schuko, 1 x RJ45 double

Optional parts:	
OT60A1	Connection pillar (page 67)

Material:	Stainless steel (1.4301), Aluminum, PVC
Dimensions:	250 x 253 x 92 mm
Instl dim:	250 x 253 x 92 mm
Protection:	IP54
Load:	Area load max. 900 kg
Supply line:	4x back, each Ø 25 mm
Feature:	Lockable with a tool, with internal tube for using the tank with the lid closed.

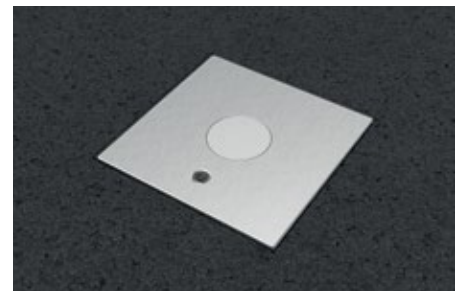
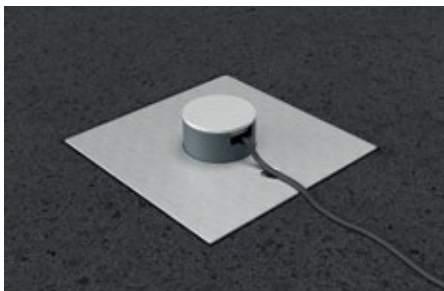

2008A

Item No.:	Equipment:
2008A	8 x Schuko
2008A1	4 x Schuko, 4 x RJ45 double

Material:	Stainless steel (1.4301), Aluminum
Dimensions:	250 x 253 x 92 mm
Instl dim:	250 x 253 x 92 mm
Protection:	IP54
Load:	Area load max. 900 kg
Supply line:	8x lateral, each Ø 25 mm
Feature:	Lockable with a tool.





2008B

Item No.:	Equipment:
2008B	8x Schuko
2008B1	4x Schuko, 4x RJ45 double

Material:	Stainless steel (1.4301), Aluminum
Dimensions:	250 x 250 x 102 mm
Instl dim:	250 x 250 x 102 mm
Protection:	IP54
Load:	Area load max. 200 kg
Supply line:	8x lateral, each Ø 25 mm
Feature:	Lockable without tools, flooring can be integrated.

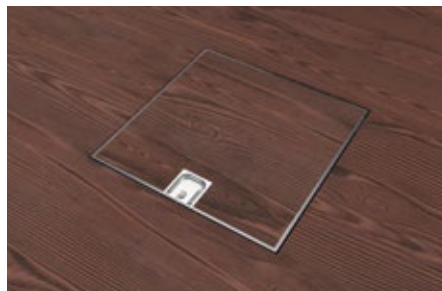

2008Q

Item No.:	Equipment:
2008Q	8x Schuko
2008Q1	4x Schuko, 4x RJ45 double

Optional parts:	
OT60A1	Connection pillar (page 67)

Material:	Stainless steel (1.4301), Aluminum, PVC
Dimensions:	250 x 253 x 92 mm
Instl dim:	250 x 253 x 92 mm
Protection:	IP54
Load:	Area load max. 900 kg
Supply line:	4x back, each Ø 25 mm
Feature:	Lockable with a tool, with internal tube for using the tank with the lid closed.

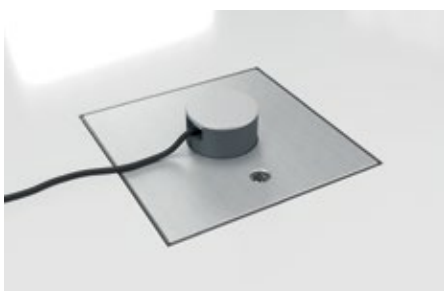



3202E

Item No.:	Equipment:
3202E	2 x Schuko (incl. box)
3202E1	1 x Schuko, 1 x RJ45 double (incl. box)
3202E2	1 x Schuko, 1 x Aerial (incl. box)

Material:	Stainless steel (1.4301), Sendzimir galvanized sheet steel
Dimensions:	180 x 145 x 82 mm
Instl dim:	166 x 146 x 80 mm
Protection:	IP20
Load:	Area load max. 120 kg
Supply line:	2x lateral, 2x back, 2x below; each Ø 25 mm

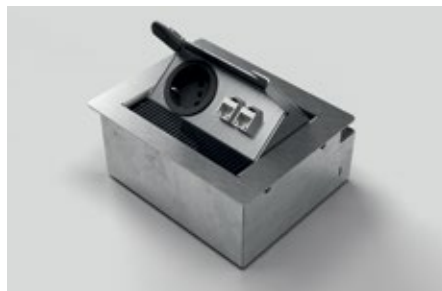

3203E

Item No.:	Equipment:
3203E	3 x Schuko (incl. box)
3203E1	2 x Schuko, 1 x RJ45 double (incl. box)
3203E2	2 x Schuko, 1 x Aerial (incl. box)

Material:	Stainless steel (1.4301), Sendzimir galvanized sheet steel
Dimensions:	230 x 140 x 82 mm
Instl dim:	224 x 145 x 80 mm
Protection:	IP10
Load:	Area load max. 120 kg
Supply line:	2x lateral, 2x back, 2x below; each Ø 25 mm

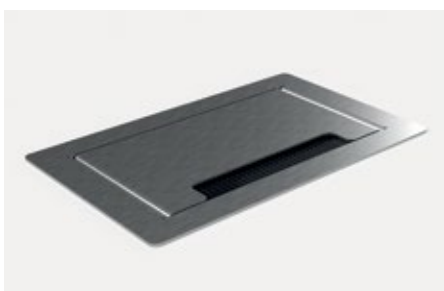



3301E

Item No.:	Equipment:
3301E	1 x Schuko (incl. box)
3301E1	1 x Schuko, 2 x RJ45 single (incl. box)

Material:	Stainless steel (1.4301), Sendzimir galvanized sheet steel
Dimensions:	110x110x62 mm
Instl dim:	102x88x60 mm
Protection:	IP20
Load:	Area load max. 120kg
Supply line:	1x front, 1x back, 2x below, each Ø 25 mm

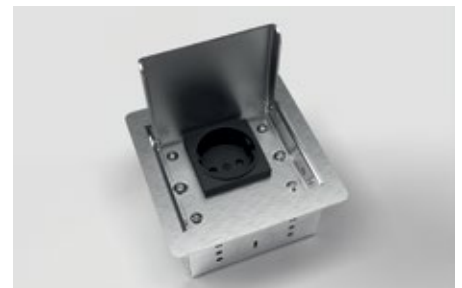

3302E

Item No.:	Equipment:
3302E	2 x Schuko (incl. box)
3302E1	1 x Schuko, 1 x RJ45 double (incl. box)
3302E2	1 x Schuko, 1 x Aerial (incl. box)

Material:	Stainless steel (1.4301), Sendzimir galvanized sheet steel
Dimensions:	160x110x62 mm
Instl dim:	146 x 90 x 60 mm
Protection:	IP20
Load:	Area load max. 120kg
Supply line:	2x front, 2x back, 2x below, each Ø 25 mm

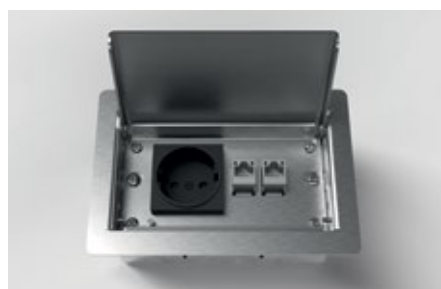



3303E

Item No.:	Equipment:
3303E	3 x Schuko (incl. box)
3303E1	2 x Schuko, 1 x RJ45 double (incl. box)
3303E2	2 x Schuko, 1 x Aerial (incl. box)

Material:	Stainless steel (1.4301), Sendzimir galvanized sheet steel
Dimensions:	220x110x62 mm
Instl dim:	207 x 88 x 60 mm
Protection:	IP30
Load:	Area load max. 120kg
Supply line:	2x front, 2x back, 2x below, each Ø 25 mm

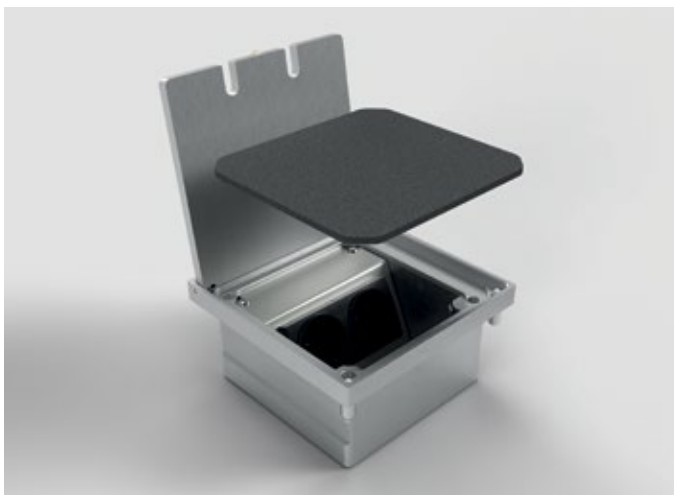
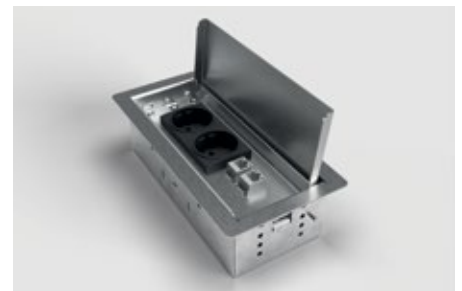

8302A

Item No.:	Equipment:
8302A	2 x Schuko
8302A1	1 x Schuko, 1 x RJ45 double
8302A2	1 x Schuko, 1 x Aerial

Material:	Aluminum
Dimensions:	140 x 140 x 76 mm
Instl dim:	140 x 140 x 76 mm
Protection:	IP64
Load:	Area load max. 900 kg
Supply line:	2x back, each Ø 25 mm
Feature:	Lockable without tools, can be closed with inserted plugs.

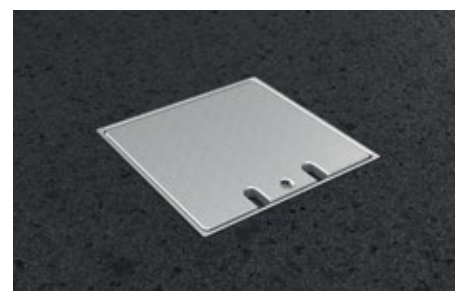
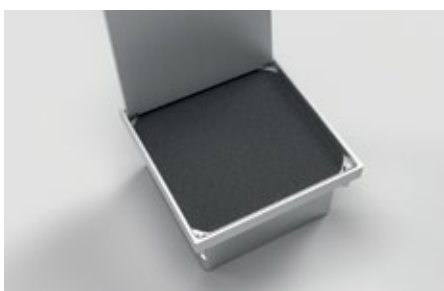



8308A

Item No.:	Equipment:
8308A	8 x Schuko
8308A1	4 x Schuko, 4 x RJ45 double

Material:	Aluminum
Dimensions:	250 x 160 x 132 mm
Instl dim:	250 x 160 x 132 mm
Protection:	IP64
Load:	Area load max. 500 kg
Supply line:	4x back, each Ø 25 mm
Feature:	Lockable without tools.



8601A

Item No.:	Equipment:
8601A	1 x Schuko
8601A1	1 x Schuko, 1 x RJ45 single

Opt. Parts:	Screed placeholder made of EPS (on demand)
12102	Screed placeholder made of PVC (on demand)

Material:	Aluminum
Dimensions:	Rim Ø 140 mm, Ø 120 x 63 mm
Instl dim:	Ø 120 x 60 mm
Protection:	IP65
Load:	Area load max. 900 kg
Supply line:	2x below, each Ø 20 mm
Feature:	Lockable without tools.





8602A

Item No.:	Equipment:
8602A	2 x Schuko
8602A1	1 x Schuko, 1 x RJ45 double
Opt. Parts:	
12104	Screed placeholder made of EPS (on demand)

Material:	Aluminum
Dimensions:	Rim Ø 149 mm, Ø 130 x 71 mm
Instl dim:	Ø 130 x 69 mm
Protection:	IP65
Load:	Area load max. 900 kg
Supply line:	2x back, 2x below, each Ø 25 mm
Feature:	Lockable without tools.



8604A

Item No.:	Equipment:
8604A	4 x Schuko
8604A1	3 x Schuko, 1 x RJ45 double
Opt. Parts:	
12106	Screed placeholder made of EPS (on demand)

Material:	Aluminum, Sendzimir galvanized sheet steel
Dimensions:	Rim Ø 218 mm, Ø 204 x 82 mm
Instl dim:	Ø 204 x 79 mm
Protection:	IP65
Load:	Area load max. 900 kg
Supply line:	4x lateral, 4x below, each Ø 25 mm
Feature:	Lockable without tools.





8701A

Item No.:	Equipment:
8701A	1 x Schuko
8701A1	1 x RJ45 double

Material:	Aluminum
Dimensions:	100 x 100 x 70 mm
Instl dim:	100 x 100 x 70 mm
Protection:	IP65
Load:	Area load max. 900 kg
Supply line:	1x front, 1x back, each M20 x 1,5 mm
Feature:	Lockable without tools.



8702A

Item No.:	Equipment:
8702A	2 x Schuko
8702A1	1 x Schuko, 1 x RJ45 double

Material:	Aluminum
Dimensions:	120 x 120 x 71 mm
Instl dim:	120 x 120 x 71 mm
Protection:	IP65
Load:	Area load max. 900 kg
Supply line:	2x back, each M25 x 1,5 mm
Feature:	Lockable without tools.



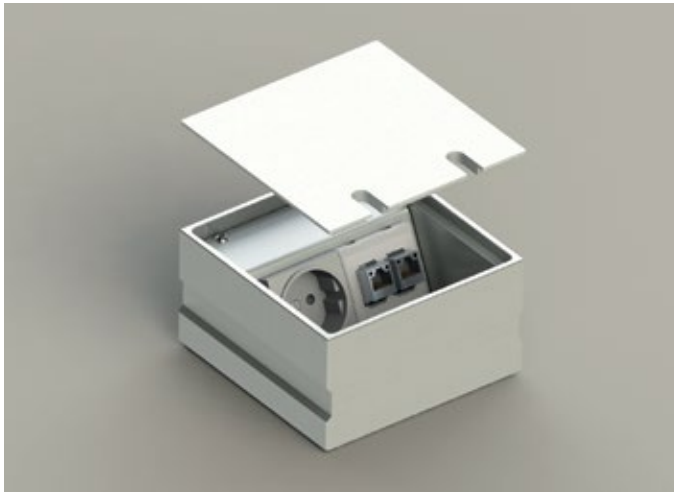

8802A

Item No.:	Equipment:
8802A	2 x Schuko
8802A1	1 x Schuko, 1 x RJ45 double
8802A2	1 x Schuko, 1 x Aerial

Material:	Aluminum
Dimensions:	125 x 125 x 72 mm
Instl dim:	125 x 125 x 72 mm
Protection:	IP20
Load:	Area load max. 300 kg
Supply line:	2x back, each Ø 25 mm
Leveling:	5 mm
Feature:	Can be closed with inserted plugs.



8802B

Item No.:	Equipment:
8802B	2 x Schuko
8802B1	1 x Schuko, 1 x RJ45 double
8802B2	1 x Schuko, 1 x Aerial

Material:	Aluminum
Dimensions:	125 x 125 x 70 mm
Instl dim:	125 x 125 x 70 mm
Protection:	IP20
Load:	Area load max. 300 kg
Supply line:	2x back, each Ø 25 mm
Leveling:	5 mm
Feature:	Rimless lid for sticking your own coverings, can be closed with inserted plugs.

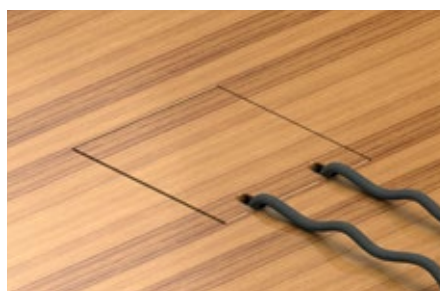



8802E

Item No.:	Equipment:
8802E	2 x Schuko
8802E1	1 x Schuko, 1 x RJ45 double
8802E2	1 x Schuko, 1 x Aerial

Material:	Aluminum, Stainless steel
Dimensions:	125 x 125 x 72 mm
Instl dim:	125 x 125 x 72 mm
Protection:	IP20
Load:	Area load max. 400 kg
Supply line:	2x back, each Ø 25 mm
Leveling:	5 mm
Feature:	Can be closed with inserted plugs.



8802T

Item No.:	Equipment:
8802T	2 x Schuko
8802T1	1 x Schuko, 1 x RJ45 double
8802T2	1 x Schuko, 1 x Aerial

Material:	Aluminum, Stainless steel
Dimensions:	135 x 135 x 76 mm
Instl dim:	135 x 135 x 76 mm
Protection:	IP20
Load:	Area load max. 200 kg
Supply line:	2x back, each Ø 25 mm
Leveling:	5 mm
Feature:	Flooring can be integrated, can be closed with inserted plugs.

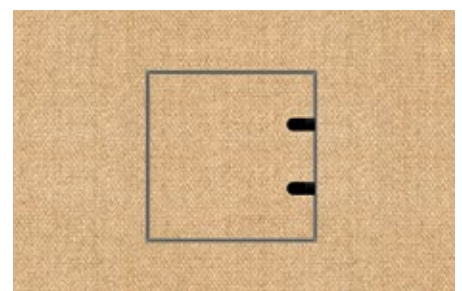



8804B

Item No.:	Equipment:
8804B	4 x Schuko
8804B1	3 x Schuko, 1 x RJ45 double
8804B2	3 x Schuko, 1 x Aerial
8804B3	2 x Schuko, 1 x RJ45 double, 1 x Aerial

Material:	Aluminum
Dimensions:	220 x 150 x 70 mm
Instl dim:	220 x 150 x 70 mm
Protection:	IP20
Load:	Area load max. 300 kg
Supply line:	4 x back, each Ø 25 mm
Leveling:	5 mm
Feature:	Rimless lid for sticking your own coverings, can be closed with inserted plugs.



8804E

Item No.:	Equipment:
8804E	4 x Schuko
8804E1	3 x Schuko, 1 x RJ45 double
8804E2	3 x Schuko, 1 x Aerial
8804E3	2 x Schuko, 1 x RJ45 double, 1 x Aerial

Material:	Aluminum, Stainless steel
Dimensions:	220 x 150 x 72 mm
Instl dim:	220 x 150 x 72 mm
Protection:	IP20
Load:	Area load max. 400 kg
Supply line:	4 x back, each Ø 25 mm
Leveling:	5 mm
Feature:	Can be closed with inserted plugs.





8804T

Item No.:	Equipment:
8804T	4 x Schuko
8804T1	3 x Schuko, 1 x RJ45 double
8804T2	3 x Schuko, 1 x Aerial
8804T3	2 x Schuko, 1 x RJ45 double, 1 x Aerial

Material:	Aluminum, Stainless steel
Dimensions:	240x160x80 mm
Instl dim:	240x160x80 mm
Protection:	IP20
Load:	Area load max. 200 kg
Supply line:	4x back, each Ø 25 mm
Leveling:	5 mm
Feature:	Covering can be integrated, ideal for carpets, can be closed with inserted plugs.

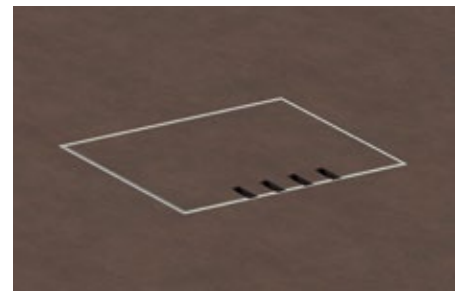

8808A

Item No.:	Equipment:
8808A	8 x Schuko
8808A1	4 x Schuko, 4 x RJ45 double

Material:	Aluminum, Stainless steel
Dimensions:	240 x 240 x 62 mm
Instl dim:	240 x 240 x 62 mm
Protection:	IP20
Load:	Area load max. 400 kg
Supply line:	8x lateral, each Ø 25 mm
Leveling:	5 mm
Feature:	Can be closed with inserted plugs.

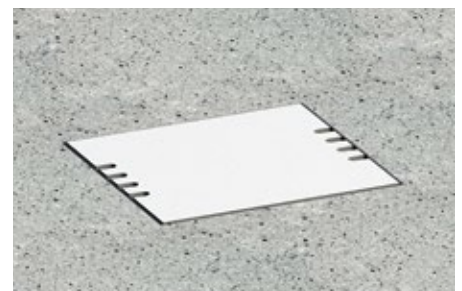



8808B

Item No.:	Equipment:
8808B	8 x Schuko
8808B1	4 x Schuko, 4 x RJ45 double

Material:	Aluminum, Stainless steel
Dimensions:	240 x 240 x 64 mm
Instl dim:	240 x 240 x 64 mm
Protection:	IP20
Load:	Area load max. 400 kg
Supply line:	8x lateral, each Ø 25 mm
Leveling:	5 mm
Feature:	Rimless lid for sticking your own coverings, can be closed with inserted plugs.



8808E

Item No.:	Equipment:
8808E	8 x Schuko
8808E1	4 x Schuko, 4 x RJ45 double

Material:	Aluminum, Stainless steel
Dimensions:	240 x 240 x 62 mm
Instl dim:	240 x 240 x 62 mm
Protection:	IP20
Load:	Area load max. 400 kg
Supply line:	8x lateral, each Ø 25 mm
Leveling:	5 mm
Feature:	Can be closed with inserted plugs.





8808T

Item No.:	Equipment:
8808T	8 x Schuko
8808T1	4 x Schuko, 4 x RJ45 double

Material:	Aluminum, Stainless steel
Dimensions:	240 x 240 x 66 mm
Instl dim:	240 x 240 x 66 mm
Protection:	IP20
Load:	Area load max. 120 kg
Supply line:	8 x lateral, each Ø 25 mm
Leveling:	5 mm
Feature:	Covering can be integrated, ideal for carpets, can be closed with inserted plugs.

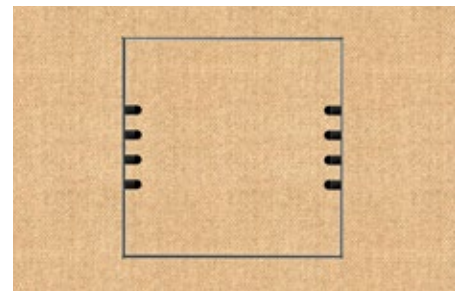

8810B

Item No.:	Equipment:
8810B	10 x Schuko
8810B1	5 x Schuko, 5 x RJ45 double

Material:	Aluminum, Stainless steel
Dimensions:	300 x 300 x 62 mm
Instl dim:	300 x 300 x 62 mm
Protection:	IP20
Load:	Area load max. 200 kg
Supply line:	10 x lateral, each Ø 25 mm
Leveling:	5 mm
Feature:	Rimless lid for sticking your own coverings, can be closed with inserted plugs.





8900B

Item No.: 8900B	Equipment: 1 x Schuko
Material:	Stainless steel, Sendzimir galvanized sheet steel, Aluminum
Dimensions:	76 x 78 x 85 mm
Instl dim:	76 x 78 x 85 mm
Protection:	IP30
Load:	Area load max. 120 kg
Supply line:	1x front, 1x back, 2x below, each Ø 25 mm
Leveling:	20 mm
Feature:	Covering can be integrated, with magnets in the lid for easy opening of the socket.

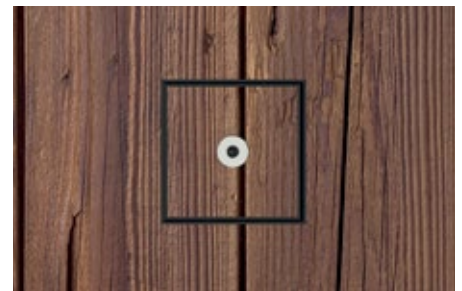

8901B

Item No.: 8901B 8901B1 8901B2	Equipment: 1x Schuko 1x RJ45 double 1x Aerial
Opt. Parts: 12201	Leveling set for height correction (see page 25)
Material:	Stainless steel, Sendzimir galvanized steel, Aluminum
Dimensions:	125 x 126 x 90–120 mm
Instl dim:	125 x 126 x 90–120 mm
Protection:	IP20
Load:	Area load max. 120 kg
Supply line:	2x lateral, 2x back, 2x below, each Ø 25 mm
Leveling:	30 mm
Feature:	Flooring can be integrated, can be closed with inserted plugs.

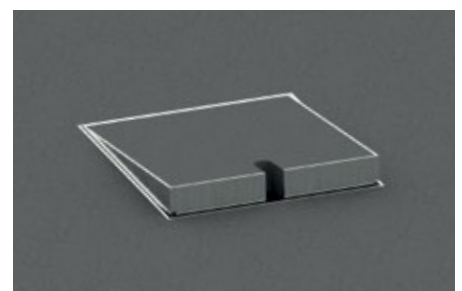
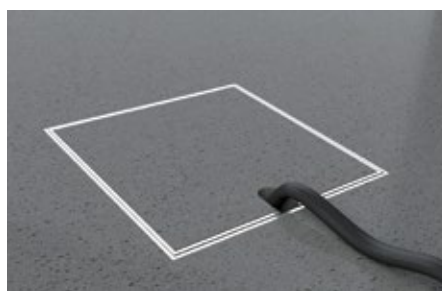



8902B

Item No.:	Equipment:
8902B	2 x Schuko
8902B1	1 x Schuko, 1 x RJ45 double
8902B2	1 x Schuko, 1 x Aerial

Opt. Parts:	
12201	Leveling set for height correction (see page 25)

Material:	Stainless steel, Sendzimir galvanized steel, Aluminum
Dimensions:	155x157x90-120 mm
Instl dim:	155x157x90-120 mm
Protection:	IP20
Load:	Area load max. 120 kg
Supply line:	2x lateral, 2x back, 2x below, each Ø 25 mm
Leveling:	30 mm
Feature:	Lid with cutouts or with brush outlet can be selected. Lid can be closed with inserted plugs.

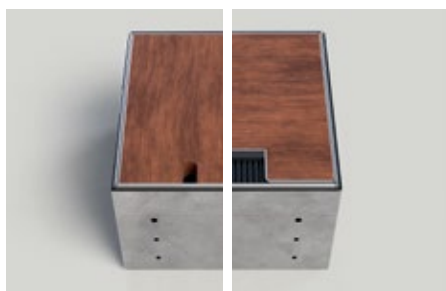

8902B



8902BB



8904B

Item No.:	Equipment:
8904B	4 x Schuko
8904B1	3 x Schuko, 1 x RJ45 double
8904B2	3 x Schuko, 1 x Aerial

Opt. Parts:	
12201	Leveling set for height correction (see page 25)

Material:	Stainless steel, Sendzimir galvanized steel, Aluminum
Dimensions:	205x157x90-120 mm
Instl dim:	205x157x90-120 mm
Protection:	IP20
Load:	Area load max. 120 kg
Supply line:	2x lateral, 2x back, 2x below, each Ø 25 mm
Leveling:	30 mm
Feature:	Lid with cutouts or with brush outlet can be selected. Lid can be closed with inserted plugs.



8904B



8904BB



8908B

Item No.:
8908B
8908B1

Equipment:
8 x Schuko
4 x Schuko, 4 x RJ45 double

Opt. Parts:
12201

Leveling set for height correction (see below)

Material: Stainless steel, Sendzimir galvanized steel, Aluminum

Dimensions: 211 x 205 x 90-120 mm

Instl dim: 211 x 205 x 90-120 mm

Protection: IP20

Load: Area load max. 120kg

Supply line: 4x front, 4x lateral, 4x back, 4x below, each Ø 25 mm
30 mm

Leveling:

Feature: **Lid with cutouts or with brush outlet can be selected.**
Flooring can be integrated, can be closed with inserted plugs.



12201

Parts for 8901 to 8908:

Item No. 12201 Leveling set for height correction for floor tanks

Professional height correction for floor boxes. The leveling set consists of Sendzimir galvanized sheet steel. It was developed for the 89 series and can be used for models 8901 to 8908.

Dimensions: 267 x 207 x 150 mm

Leveling range: 53-153 mm in 20 mm steps

The delivery takes place without the illustrated floor box.



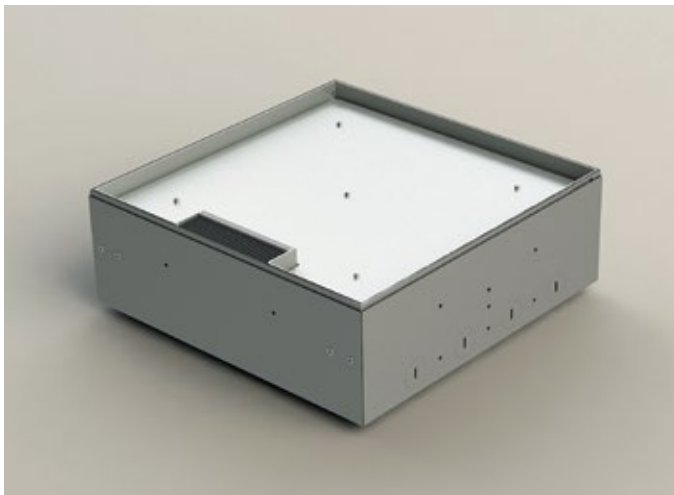

8912B

Item No.:	Equipment:
8912B	12 x Schuko
8912B1	8 x Schuko, 4 x RJ45 double
<hr/>	
Material:	Stainless steel, Sendzimir galvanized sheet steel, Aluminum
Dimensions:	310 x 304 x 90–120 mm
Instl dim:	310 x 304 x 90–120 mm
Protection:	IP20
Load:	Area load max. 120 kg
Supply line:	4 x front, 4 x lateral, 4 x back, 8 x below, each Ø 25 mm
Leveling:	30 mm
Feature:	Flooring can be integrated, can be closed with inserted plugs. Alternatively, cover with brush outlet can be ordered.

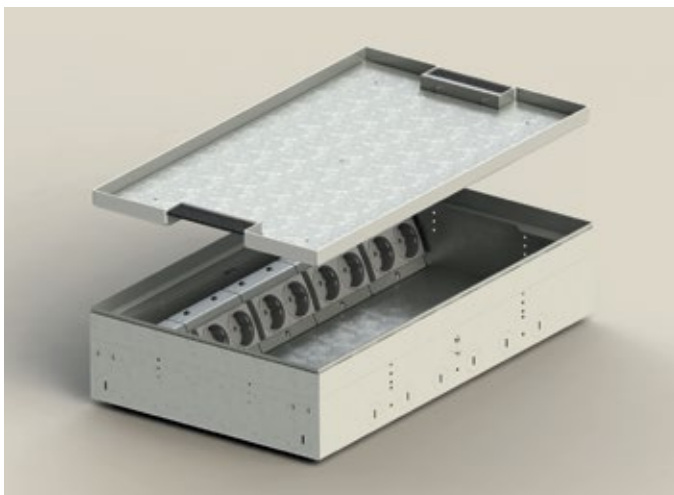
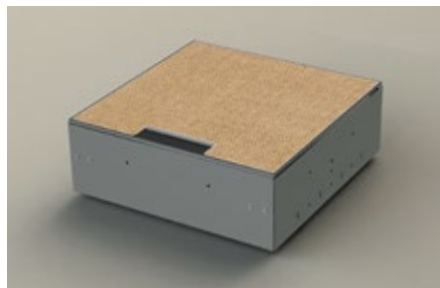

8920B

Item No.:	Equipment:
8920B	20 x Schuko
8920B1	10 x Schuko, 10 x RJ45 double
<hr/>	
Material:	Stainless steel, Sendzimir galvanized sheet steel, Aluminum
Dimensions:	504 x 310 x 90–120 mm
Instl dim:	504 x 310 x 90–120 mm
Protection:	IP20
Load:	Area load max. 120 kg
Supply line:	6x front, 4x lateral, 6x back, 12x below, each Ø 25 mm
Leveling:	30 mm
Feature:	Flooring can be integrated in the reversible cover, can be closed with inserted plugs. The lid features via a brush outlet.





9901A

Item No.:
 9901A
 9901A1

Equipment:
 1x Schuko
 1x RJ45 double

Opt. Parts:
 12102
 12109

Screed placeholder made of EPS
 Screed placeholder made of PVC

Material: Aluminum
Dimensions: Rim Ø 140 mm, Ø 120 x 74 mm
Instl dim: Ø 120 x 72 mm
Protection: IP20
Load: Area load max. 200 kg
Supply line: 2x back, 2x below, each Ø 25 mm
Feature: Flooring can be integrated in the reversible cover, can be closed with inserted plugs.



9902A

Item No.:
 9902A
 9902A1
 9902A2

Equipment:
 2x Schuko
 1x Schuko, 1x RJ45 double
 1x Schuko, 1x Aerial

Opt. Parts:
 12107
 12108

Screed placeholder made of EPS
 Screed placeholder made of PVC

Material: Aluminum
Dimensions: Rim Ø 170 mm, Ø 150 x 74 mm
Instl dim: Ø 150 x 72 mm
Protection: IP20
Load: Area load max. 200 kg
Supply line: 2x back, 2x below, each Ø 25 mm
Feature: Flooring can be integrated in the reversible cover, can be closed with inserted plugs.





9902B

Item No.:	Equipment:
9902B	2 x Schuko
9902B1	1 x Schuko, 1 x RJ45 double
9902B2	1 x Schuko, 1 x Aerial
9902B3	1 x Schuko, 1 x USB Charge 2fach

Opt. Parts:	
12107	Screed placeholder made of EPS

Material:	Aluminum
Dimensions:	Ø 150 x 76–100 mm
Instl dim:	Ø 150 x 76–100 mm
Protection:	IP20
Load:	Area load max. 400 kg
Supply line:	2x back, 2x below, each Ø 25 mm
Feature:	Can be closed with inserted plugs. Possible height adjustment (30 mm) via integrable leveling feet.



9902D

Item No.:	Equipment:
9902D	2 x Schuko
9902D1	1 x Schuko, 1 x RJ45 double
9902D2	1 x Schuko, 1 x Aerial

Opt. Parts:	
12108	Screed placeholder made of PVC

Material:	Aluminum
Dimensions:	Rim Ø 170 mm, Ø 150 x 77 mm
Instl dim:	Ø 150 x 75 mm
Protection:	IP65
Load:	Area load max. 500 kg
Supply line:	2x back, 2x below, each Ø 25 mm
Feature:	By turning the lid by 180° it is suitable for cleaning with wet sweepers. Can be closed with inserted plugs.



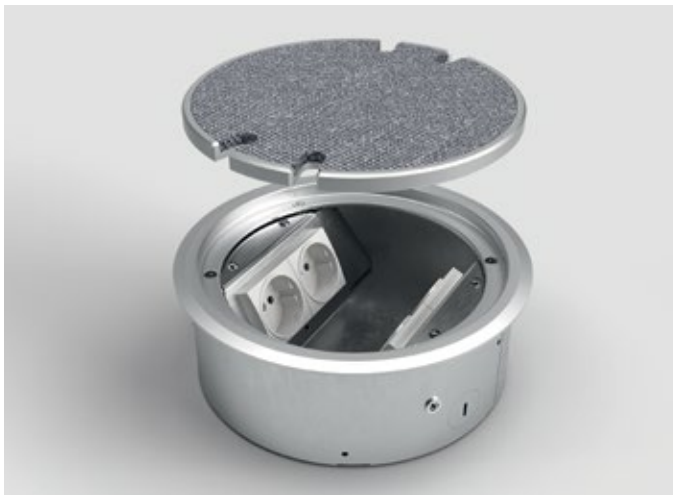

9904A

Item No.:	Equipment:
9904A	4 x Schuko
9904A1	2 x Schuko, 2 x RJ45 double
9904A2	2 x Schuko, 1 x RJ45 double, 1 x Aerial

Opt. Parts:	
12106	Screed placeholder made of EPS

Material:	Aluminum, Sendzimir galvanized sheet steel
Dimensions:	Rim \varnothing 220 mm, \varnothing 205 x 80 mm
Instl dim:	\varnothing 205 x 76 mm
Protection:	IP20
Load:	Area load max. 200 kg
Supply line:	4x lateral, 4x below, each \varnothing 25 mm
Feature:	Flooring can be integrated in the reversible cover, can be closed with inserted plugs.



← Main menu



Floor sockets
→ Outdoor



7003A

Item No.: 7003A	Equipment: 2x Schuko, 1 x RJ45 double
Material: Aluminum	
Dimensions: Ø 150 x 108 mm	
Instl dim: Ø 150 x 108 mm	
Protection: IP67	
Load: Area load max. 900 kg	
Supply line: 2x below, each M25 x1,5mm	
Feature: Lockable with a tool, waterproof when closed.	

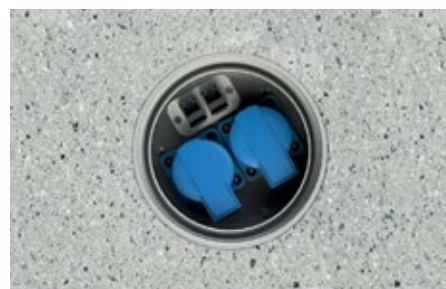

7501A

Item No.: 7501A 7501A1	Equipment: 1x Schuko 1x RJ45 single
Opt. Parts: 12256	Rain protection set (page 37)
Material: Aluminum, PVC	
Dimensions: Ø 114 x 82 mm	
Instl dim: Ø 100 x 80 mm	
Protection: IP67	
Load: Area load max. 900 kg	
Supply line: 2x lateral, each M25 x1,5mm	
Feature: Lockable with a special key, waterproof when closed.	





7601A

Item No.: 7601A	Equipment: 1 x Schuko
Opt. Parts: 12256	Rain protection set (page 37)
Material:	Aluminum, PVC
Dimensions:	100 x 100 x 82 mm
Instl dim:	100 x 100 x 82 mm
Protection:	IP67
Load:	Area load max. 900 kg
Supply line:	2x lateral, each M25 x 1,5 mm
Feature:	Lockable with a special key, waterproof when closed.

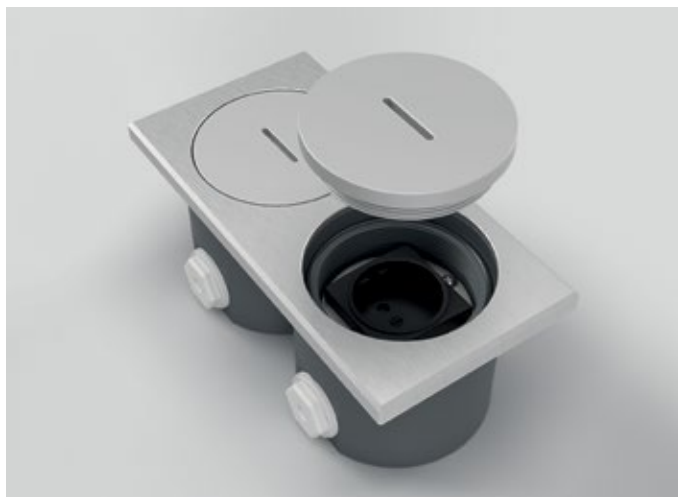

7602A

Item No.: 7602A 7602A1	Equipment: 2 x Schuko 1 x Schuko, 1 x RJ45 single
Opt. Parts: 12256	Rain protection set (page 37)
Material:	Aluminum, PVC
Dimensions:	200 x 100 x 82 mm
Instl dim:	200 x 100 x 82 mm
Protection:	IP67
Load:	Area load max. 900 kg
Supply line:	2x lateral, each M25 x 1,5 mm
Feature:	Lockable with a special key, waterproof when closed.





7604A

Item No.:
7604A
7604A1

Equipment:
4x Schuko
2x Schuko, 2x RJ45 single

Opt. Parts:
12256

Rain protection set (page 37)

Material: Aluminum, PVC
Dimensions: 200x200x82 mm
Instl dim: 200x200x82 mm
Protection: IP67
Load: Area load max. 900 kg
Supply line: 4x lateral, each M25x1,5 mm
Feature: Lockable with a special key, waterproof when closed.

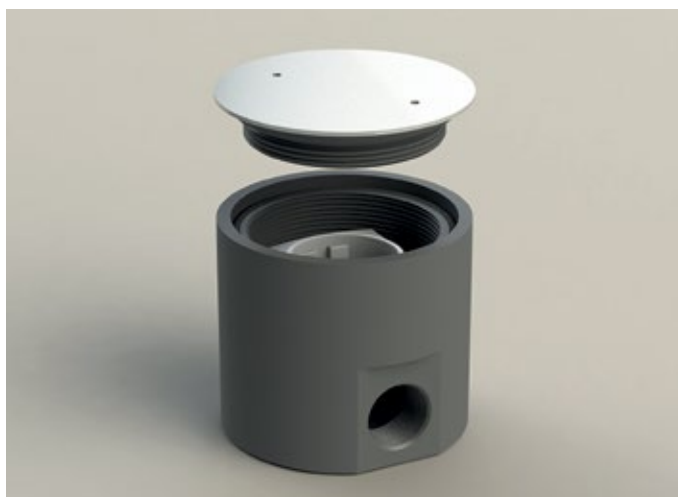

7701E

Item No.:
7701E
7701E1

Equipment:
1x Schuko
1x RJ45 single

Opt. Parts:
12252
12256

Leveling ring (page 36)
Rain protection set (page 37)

Material: Aluminum, PVC, Lid surface Stainless steel brushed
Dimensions: Ø 90x80 mm
Instl dim: Ø 90x80 mm
Protection: IP67
Load: Area load max. 200 kg
Supply line: 2x lateral, each M25x1,5 mm
Feature: Lockable with a special key, waterproof when closed.



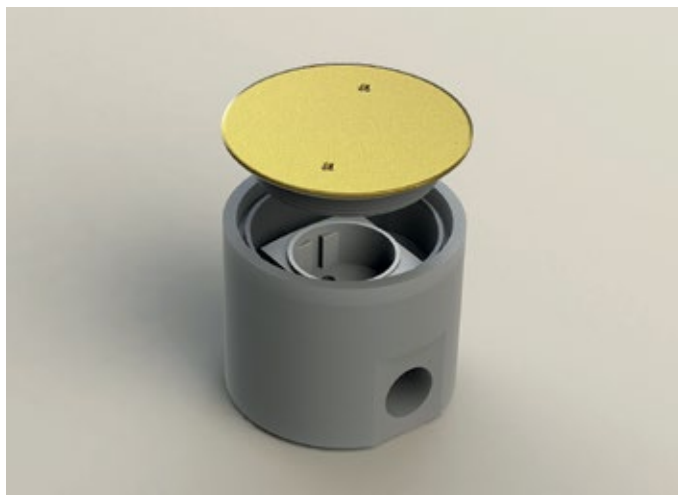

7701M

Item No.:
7701M
7701M1

Equipment:
1x Schuko
1x RJ45 single

Opt. Parts:
12252 Leveling ring collar (page 36)
12256 Rain protection set (page 37)

Material: Aluminum, PVC, Brass cover surface
Dimensions: Ø 90x80 mm
Instl dim: Ø 90x80 mm
Protection: IP67
Load: Area load max. 200 kg
Supply line: 2x lateral, each M25x1,5 mm
Feature: Lockable with a special key, waterproof when closed.

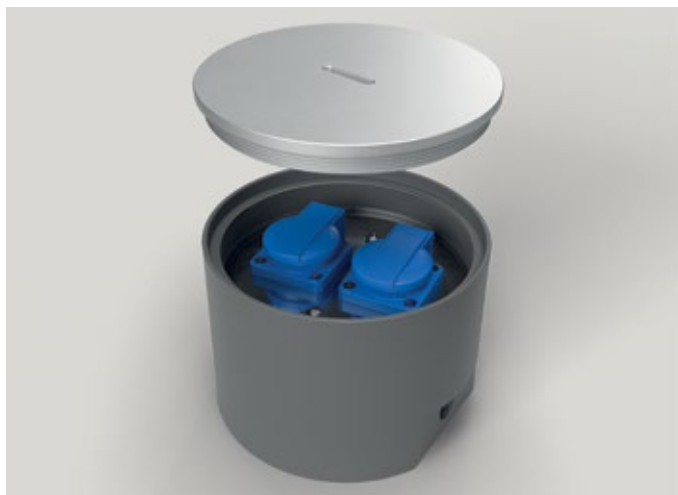

7702A

Item No.:
7702A

Equipment:
2x Schuko

Opt. Parts:
12251 Leveling ring (page 35)
12255 Rain protection set (page 36)

Material: Aluminum, PVC
Dimensions: Ø 170x120 mm
Instl dim: Ø 170x120 mm
Protection: IP67
Load: Area load max. 200 kg
Supply line: 2x lateral, each M25x1,5 mm
Feature: Lockable with a special key, waterproof when closed.

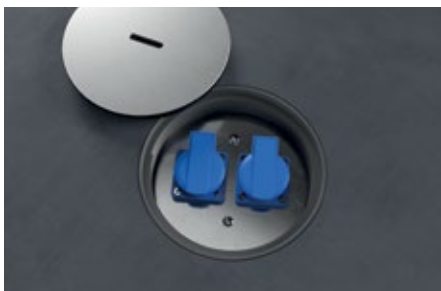



7704A

Item No.: 7704A	Equipment: 4 x Schuko
Opt. Parts: 12251 12255	Leveling ring (see below) Rain protection set (page 36)
Material:	Aluminum, PVC
Dimensions:	Ø 170 x 120 mm
Instl dim:	Ø 170 x 120 mm
Protection:	IP67
Load:	Area load max. 200 kg
Supply line:	2x lateral, each M25 x 1,5 mm
Feature:	Lockable with a special key, waterproof when closed.



12251

Parts for 7702A, 7704A and 7705A:

Item No. 12251 Aluminum leveling ring

Solid aluminum ring for fastening the floor socket in the wooden floor/
raised floor.

Aluminum leveling ring dimensions: Ø 200 x 8 mm





12252

Parts for 7701E, 7701M:

Item No. 12252 Aluminum leveling ring

Solid aluminum ring for fastening the floor socket in the wooden floor/
raised floor.

Aluminum leveling ring dimensions: \varnothing 120 x 8 mm



12255

Parts for 7702A and 7704A:

Item No. 12255 extension tube and protective cap

Extension tube made of solid PVC (RAL 7011 gray) and protective cap
made of soft PVC (black) to protect against rain when plugged in.

Dimensions extension tube: \varnothing 170 x 120 mm

Dimensions protective cap: \varnothing 174 x 62 mm

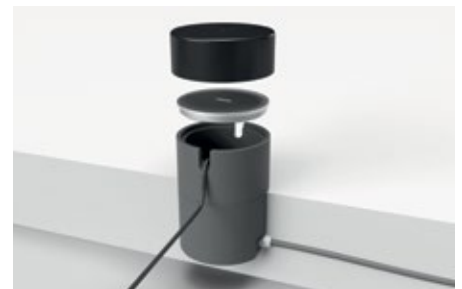
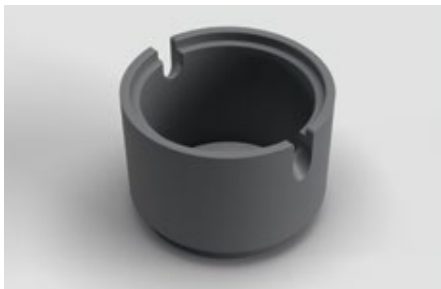



12256

Parts for **7501A, 7601A, 7602A, 7604A and 7701E/M:**

Item No. 12256 extension tube and protective cap

Extension tube made of solid PVC (RAL 7011 gray) and protective cap made of soft PVC (black) to protect against rain when plugged in.

Dimensions extension tube: \varnothing 79 x 80 mm

Dimensions protective cap: \varnothing 80 x 40 mm

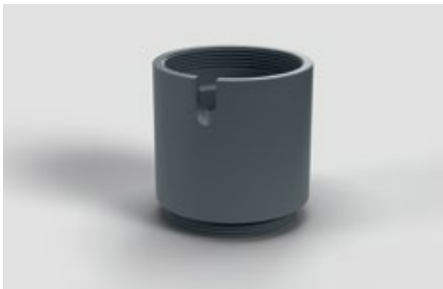



Hollow space floor box system



8501B

Item No.:	Equipment:
8501B	1x Schuko
8501B1	1x RJ45 double
8501B2	1x Aerial

Material: Sendzimir galvanized sheet steel, Stainless steel, Aluminum

Dimensions: 150 x 150 x 103 mm

Instl dim: 125 x 126 x 101 mm

Protection: IP20

Load: Area load max. 120 kg

Supply line: 2x lateral, 2x back, 2x below, each Ø 25 mm

Feature: Covering can be integrated, can be closed with inserted plugs.

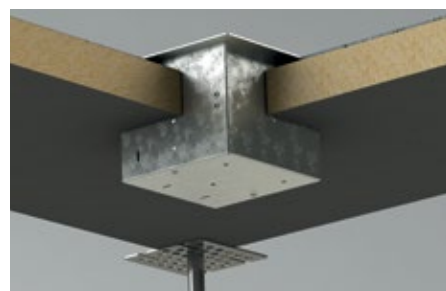

8501E

Item No.:	Equipment:
8501E	1x Schuko
8501E1	1x RJ45 double
8501E2	1x Aerial

Material: Sendzimir galvanized sheet steel, Stainless steel, Aluminum

Dimensions: 150 x 150 x 103 mm

Instl dim: 125 x 126 x 101 mm

Protection: IP20

Load: Area load max. 120 kg

Supply line: 2x lateral, 2x back, 2x below, each Ø 25 mm

Feature: Can be closed with inserted plugs.

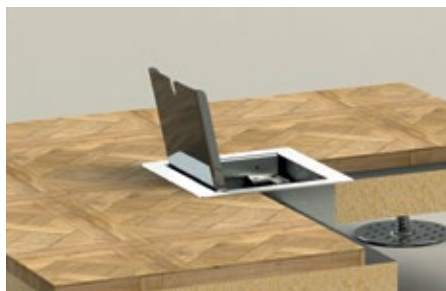

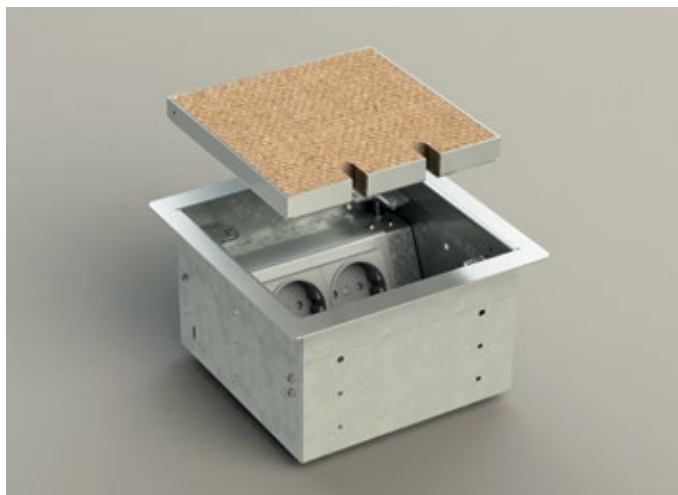

8502B

Item No.:	Equipment:
8502B	2 x Schuko
8502B1	1 x Schuko, 1 x RJ45 double
8502B2	1 x Schuko, 1 x Aerial

Material: Sendzimir galvanized sheet steel, Stainless steel, Aluminum

Dimensions: 180 x 180 x 103 mm

Instl dim: 157 x 155 x 101 mm

Protection: IP20

Load: Area load max. 120 kg

Supply line: 2x lateral, 2x back, 2x below, each Ø 25 mm

Feature: Covering can be integrated, can be closed with inserted plugs.

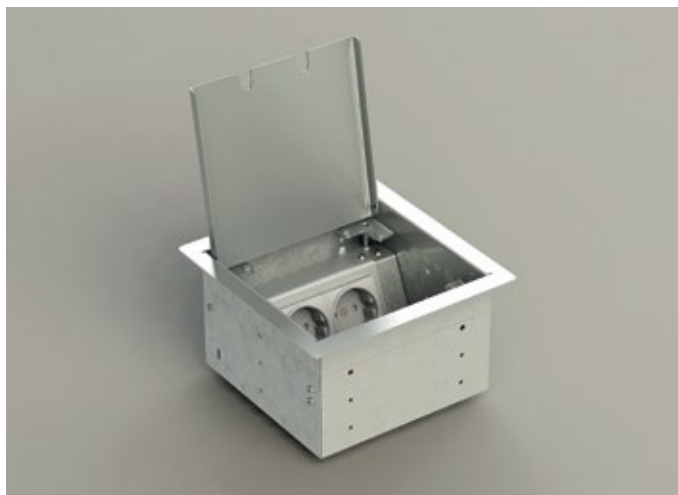

8502E

Item No.:	Equipment:
8502E	2 x Schuko
8502E1	1 x Schuko, 1 x RJ45 double
8502E2	1 x Schuko, 1 x Aerial

Material: Sendzimir galvanized sheet steel, Stainless steel, Aluminum

Dimensions: 180 x 180 x 103 mm

Instl dim: 157 x 155 x 101 mm

Protection: IP20

Load: Area load max. 120 kg

Supply line: 2x lateral, 2x back, 2x below, each Ø 25 mm

Feature: Can be closed with inserted plugs.

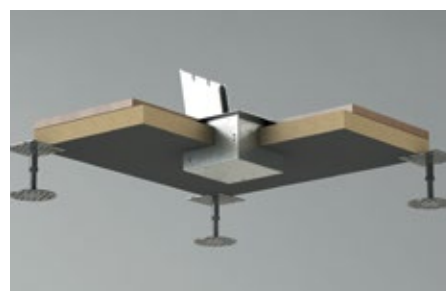



8504B

Item No.:	Equipment:
8504B	4 x Schuko
8504B1	3 x Schuko, 1x RJ45 double
8504B2	3 x Schuko, 1x Aerial
8504B3	2 x Schuko, 1x Aerial, 1x RJ45 double

Material:	Sendzimir galvanized sheet steel, Stainless steel, Aluminum
Dimensions:	230 x 180 x 103 mm
Instl dim:	205 x 157 x 101 mm
Protection:	IP20
Load:	Area load max. 120 kg
Supply line:	2x lateral, 2x back, 2x below, each Ø 25 mm
Feature:	Covering can be integrated, can be closed with inserted plugs.



8504E

Item No.:	Equipment:
8504E	4 x Schuko
8504E1	3 x Schuko, 1x RJ45 double
8504E2	3 x Schuko, 1x Aerial
8504E3	2 x Schuko, 1x Aerial, 1x RJ45 double

Material:	Sendzimir galvanized sheet steel, Stainless steel, Aluminum
Dimensions:	230 x 180 x 103 mm
Instl dim:	205 x 157 x 101 mm
Protection:	IP20
Load:	Area load max. 120 kg
Supply line:	2x lateral, 2x back, 2x below, each Ø 25 mm
Feature:	Can be closed with inserted plugs.





8508B

Item No.:
8508B
8508B1

Equipment:
8 x Schuko
4 x Schuko, 4 x RJ45 double

Material: Sendzimir galvanized sheet steel, Stainless steel, Aluminum

Dimensions: 230 x 230 x 103 mm

Instl dim: 205 x 207 x 101 mm

Protection: IP20

Load: Area load max. 120 kg

Supply line: 4x front, 4x lateral, 4x back, 4x below, each Ø 25 mm

Feature: Covering can be integrated, can be closed with inserted plugs.

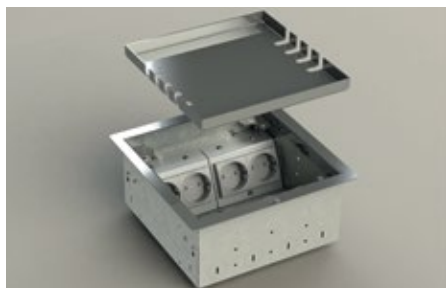

8508E

Item No.:
8508E
8508E1

Equipment:
8 x Schuko
4 x Schuko, 4 x RJ45 double

Material: Sendzimir galvanized sheet steel, Stainless steel, Aluminum

Dimensions: 230 x 230 x 103 mm

Instl dim: 205 x 207 x 101 mm

Protection: IP20

Load: Area load max. 120 kg

Supply line: 4x front, 4x lateral, 4x back, 4x below, each Ø 25 mm

Feature: Can be closed with inserted plugs.





8512B

Item No.:	Equipment:
8512B	12 x Schuko
8512B1	8 x Schuko, 4 x RJ45 double

Material:	Sendzimir galvanized sheet steel, Stainless steel, Aluminum
Dimensions:	350 x 350 x 107 mm
Instl dim:	304 x 310 x 105 mm
Protection:	IP20
Load:	Area load max. 120 kg
Supply line:	4x front, 4x lateral, 4x back, 8x below, each Ø 25 mm
Feature:	Covering can be integrated, can be closed with inserted plugs.

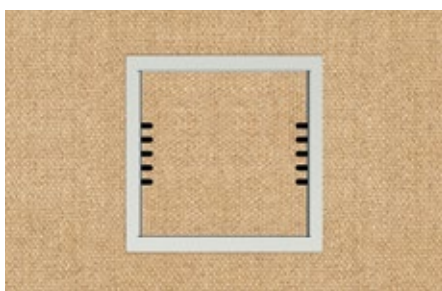

8902H

Item No.:	Equipment:
8902H	2 x Schuko
8902H1	1 x Schuko, 1 x RJ45 double
8902H2	1 x Schuko, 1 x Aerial

Material:	Sendzimir galvanized sheet steel, Stainless steel, Aluminum
Dimensions:	200 x 200 x 90–120 mm
Instl dim:	167 x 167 x 90–120 mm
Protection:	IP20
Load:	Area load max. 120 kg
Supply line:	2x lateral, 2x back, 2x below, each Ø 25 mm
Leveling:	30 mm
Feature:	Covering can be integrated, can be closed with inserted plugs.

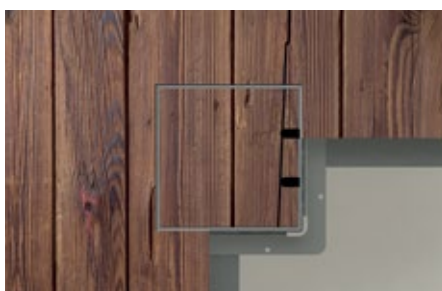
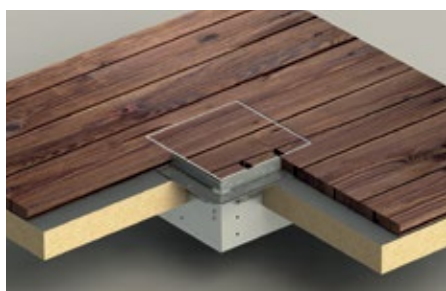



8904H

Item No.:	Equipment:
8904H	4 x Schuko
8904H1	3 x Schuko, 1x RJ45 double
8904H2	3 x Schuko, 1x Aerial
8904H3	2 x Schuko, 1x RJ45 double, 1x Aerial

Material:	Senzimir galvanized sheet steel, Stainless steel, Aluminum
Dimensions:	250 x 200 x 90-120 mm
Instl dim:	217 x 167 x 90-120 mm
Protection:	IP20
Load:	Area load max. 120 kg
Supply line:	2x lateral, 2x back, 2x below, each Ø 25 mm
Leveling:	30 mm
Feature:	Covering can be integrated, can be closed with inserted plugs.

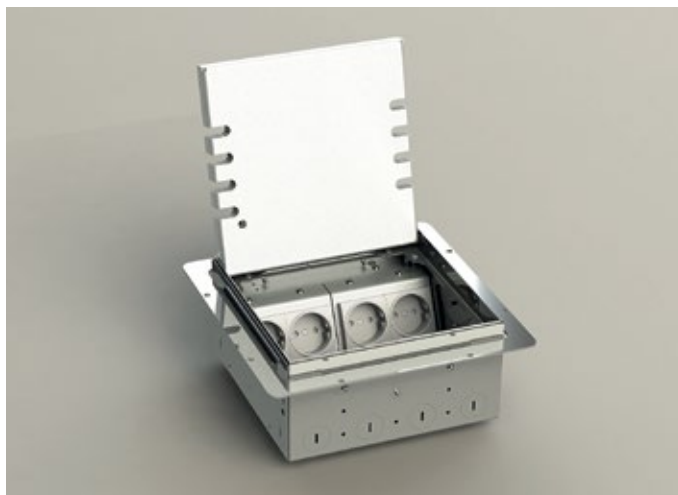

8908H

Item No.:	Equipment:
8908H	8 x Schuko
8908H1	4 x Schuko, 4 x RJ45 double

Material:	Senzimir galvanized sheet steel, Stainless steel, Aluminum
Dimensions:	250 x 250 x 90-120 mm
Instl dim:	217 x 217 x 90-120 mm
Protection:	IP20
Load:	Area load max. 120 kg
Supply line:	4x front, 4x lateral, 4x back, 4x below, each Ø 25 mm
Leveling:	30 mm
Feature:	Covering can be integrated, can be closed with inserted plugs.

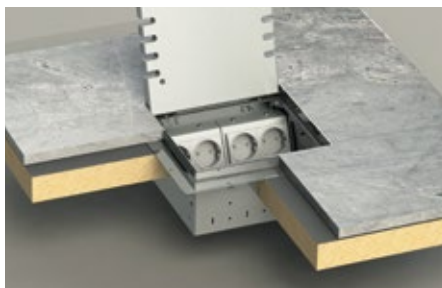



9908A

Item No.:
9908A
9908A1

Equipment:
8 x Schuko
4 x Schuko, 4 x RJ45 double

Material: Sendzimir galvanized sheet steel, Aluminum
Dimensions: Ø 320 x 80 mm
Instl dim: Ø 298 x 76 mm
Protection: IP20
Load: Area load max. 200 kg
Supply line: 8x lateral, 8x below, each Ø 25 mm
Feature: Covering can be integrated, can be closed with inserted plugs.



9912A

Item No.:
9912A
9912A1

Equipment:
12 x Schuko
8 x Schuko, 4 x RJ45 double

Material: Sendzimir galvanized sheet steel, Aluminum
Dimensions: Ø 380 x 90 mm
Instl dim: Ø 350 x 85 mm
Protection: IP40
Load: Area load max. 200 kg
Supply line: 24x lateral, 12x below, each Ø 25 mm
Feature: Can be closed with inserted plugs.





9912T

Item No.:	Equipment:
9912T	12 x Schuko
9912T1	8 x Schuko, 4 x RJ45 double

Material:	Sendzimir galvanized sheet steel, Aluminum
Dimensions:	Ø 380 x 90 mm
Instl dim:	Ø 350 x 85 mm
Protection:	IP40
Load:	Area load max. 200 kg
Supply line:	24x lateral, 12x below, each Ø 25 mm
Feature:	The lid has a floor covering recess of 6 mm and can be closed with inserted plugs.

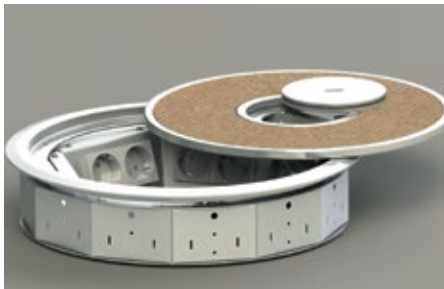

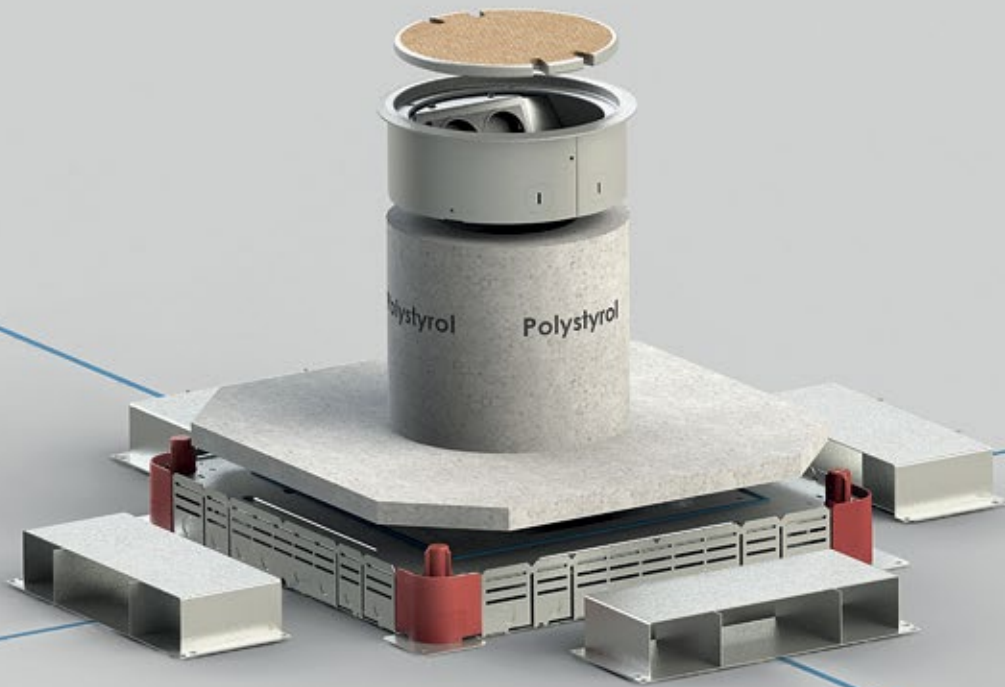

Underfloor systems

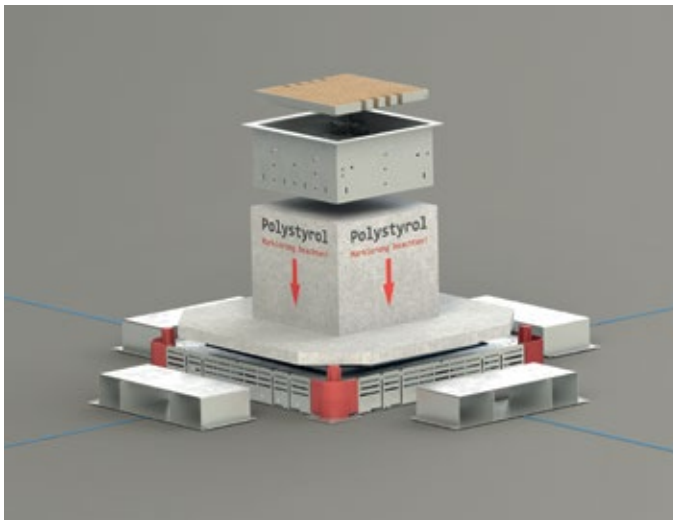

8508BK

Item No.:	Equipment:
8508BK	8 x Schuko
8508BK1	4 x Schuko, 4 x RJ45 double
Parts:	
12181	Underfloor box, 492 x 492 x 60 mm
12183	Underfloor duct 3-track, 350 x 2000 x 48 mm
Material:	Sendzimir galvanized sheet steel, Stainless steel, Aluminum
Dimensions:	230 x 230 x 103 mm (Floor socket)
Instl dim:	205 x 207 x 101 mm (Floor socket)
Protection:	IP20
Load:	Area load max. 120 kg
Supply line:	4x front, 4x lateral, 4x back, 4x below, each Ø 25 mm
Feature:	Covering can be integrated, can be closed with inserted plugs. For a subsequent connection, the bottom of the box can be opened without affecting the connected units.

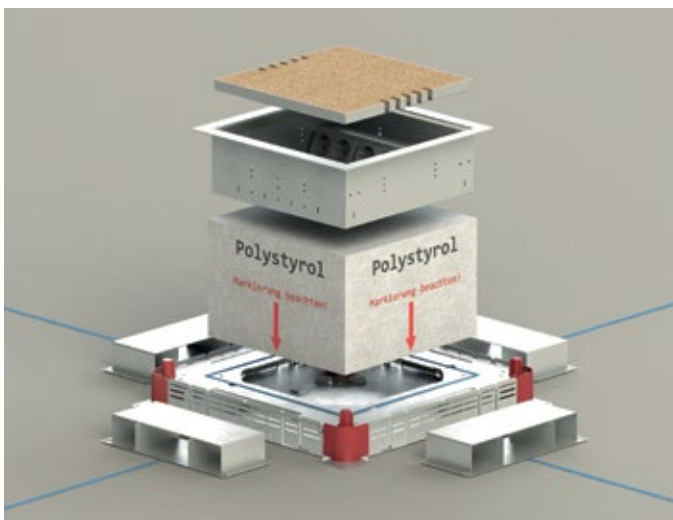
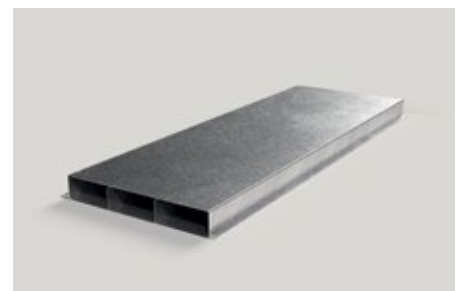
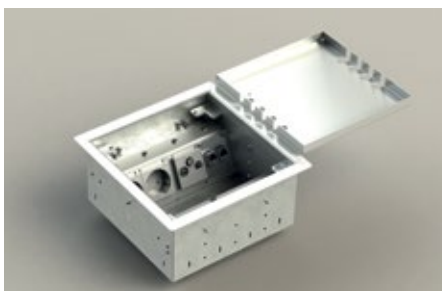

8512BK

Item No.:	Equipment:
8512BK	12 x Schuko
8512BK1	8 x Schuko, 4 x RJ45 double
Parts:	
12181	Underfloor box, 492 x 492 x 60 mm
12183	Underfloor duct 3-track, 350 x 2000 x 48 mm
Material:	Sendzimir galvanized sheet steel, Stainless steel, Aluminum
Dimensions:	350 x 350 x 107 mm (Floor socket)
Instl dim:	304 x 310 x 105 mm (Floor socket)
Protection:	IP20
Load:	Area load max. 120 kg
Supply line:	4x front, 4x lateral, 4x back, 8x below, each Ø 25 mm
Feature:	Covering can be integrated, can be closed with inserted plugs. For a subsequent connection, the bottom of the box can be opened without affecting the connected units.

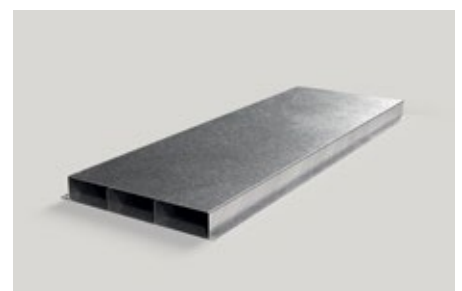



8912BK

Item No.:	Equipment:
8912BK	12 x Schuko
8912BK1	8 x Schuko, 4 x RJ45 double
Parts:	
12181	Underfloor box, 492 x 492 x 60 mm
12183	Underfloor duct 3-track, 350 x 2000 x 48 mm
Material:	Sendzimir galvanized sheet steel, Stainless steel, Aluminum
Dimensions:	310 x 304 x 103 mm (Floor socket)
Instl dim:	310 x 304 x 103 mm (Floor socket)
Protection:	IP20
Load:	Area load max. 120 kg
Supply line:	4x front, 4x lateral, 4x back, 8x below, each Ø 25 mm
Feature:	Covering can be integrated, can be closed with inserted plugs. For a subsequent connection, the bottom of the box can be opened without affecting the connected units.

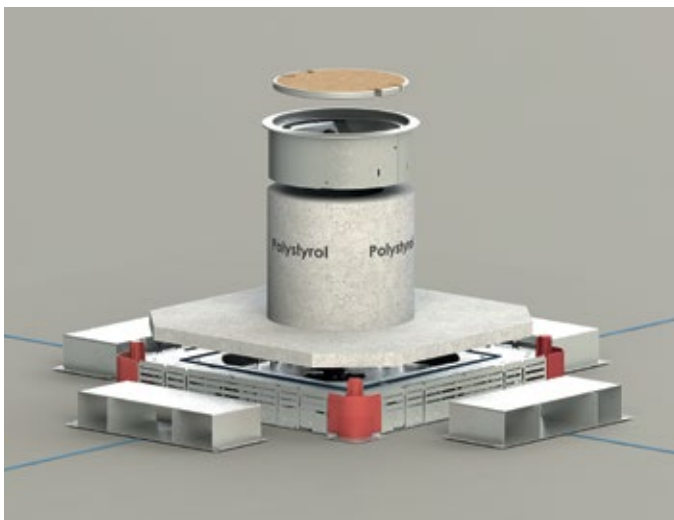
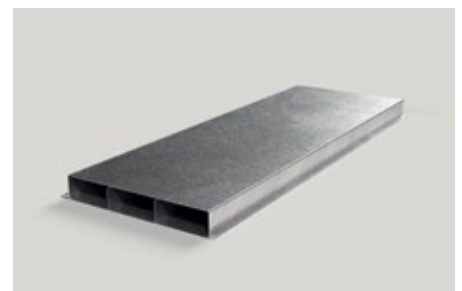

9904AK

Item No.:	Equipment:
9904AK	4 x Schuko
9904AK1	2 x Schuko, 2 x RJ45 double
Parts:	
12181	Underfloor box, 492 x 492 x 60 mm
12183	Underfloor duct 3-track, 350 x 2000 x 48 mm
Material:	Aluminum, Sendzimir galvanized sheet steel
Dimensions:	Rim Ø 220 mm, Ø 205 x 80 mm (Floor socket)
Instl dim:	Ø 205 x 76 mm (Floor socket)
Protection:	IP20
Load:	Area load max. 200 kg
Supply line:	4x lateral, 4x below, each Ø 25 mm
Feature:	Covering can be integrated, can be closed with inserted plugs. For a subsequent connection, the bottom of the box can be opened without affecting the connected units.

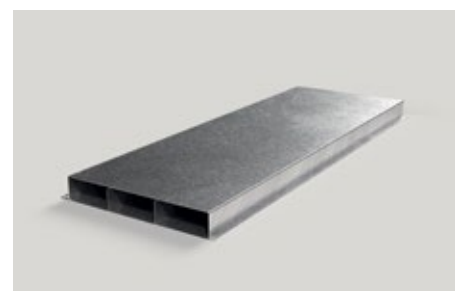

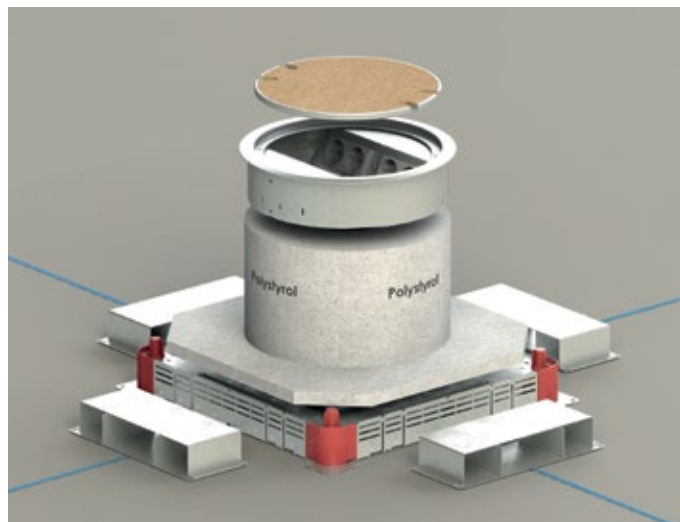

9908AK

Item No.:	Equipment:
9908AK	8 x Schuko
9908AK1	4 x Schuko, 4 x RJ45 double
Parts:	
12181	Underfloor box, 492 x 492 x 60 mm
12183	Underfloor duct 3-track, 350 x 2000 x 48 mm
Material:	Aluminum, Sendzimir galvanized sheet steel
Dimensions:	Rim \varnothing 320 mm, \varnothing 298 x 80 mm (Floor socket)
Instl dim:	\varnothing 298 x 76 mm (Floor socket)
Protection:	IP20
Load:	Area load max. 200 kg
Supply line:	8 x lateral, 8 x below, each \varnothing 25 mm
Feature:	Covering can be integrated, can be closed with inserted plugs. For a subsequent connection, the bottom of the box can be opened without affecting the connected units.

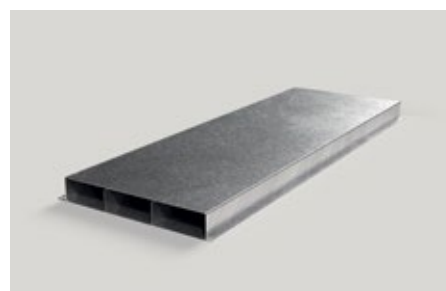



CEE-floor sockets

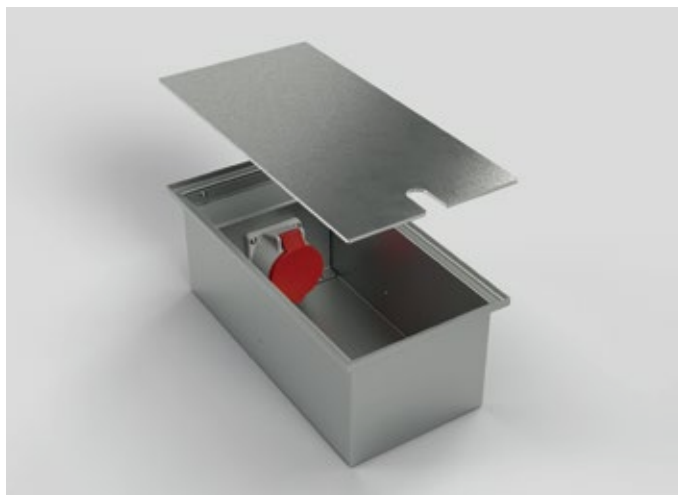

6400E

Item No.:	Equipment:
6400E1	1x CEE 5/16A 400V/6h
6400E2	1x CEE 5/32A 400V/6h

Material:	Aluminum, Stainless steel
Dimensions:	400 x 200 x 150 mm
Instl dim:	400 x 200 x 150 mm
Protection:	IP10
Load:	Area load max. 200 kg
Supply line:	2x back, each Ø 25 mm
Feature:	Can be closed with inserted plugs.

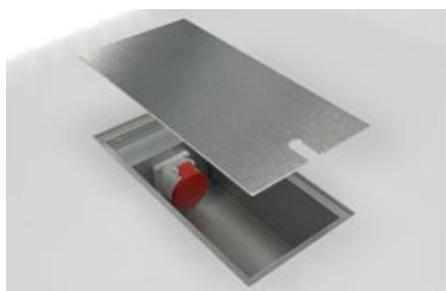

6522A

Item No.:	Equipment:
6522A	1x CEE 5/16A, 1x CEE 5/32A, 2x Schuko

Material:	Aluminum, Stainless steel
Dimensions:	400 x 400 x 117 mm
Instl dim:	400 x 400 x 117 mm
Protection:	IP65
Load:	Area load max. 900 kg
Supply line:	4x back, each Ø 25 mm
Feature:	Lockable with a tool.

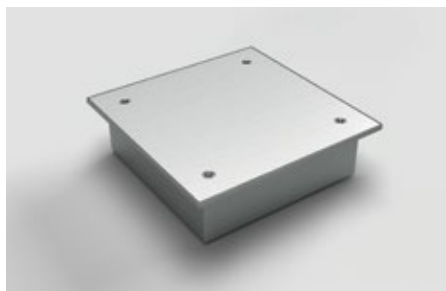

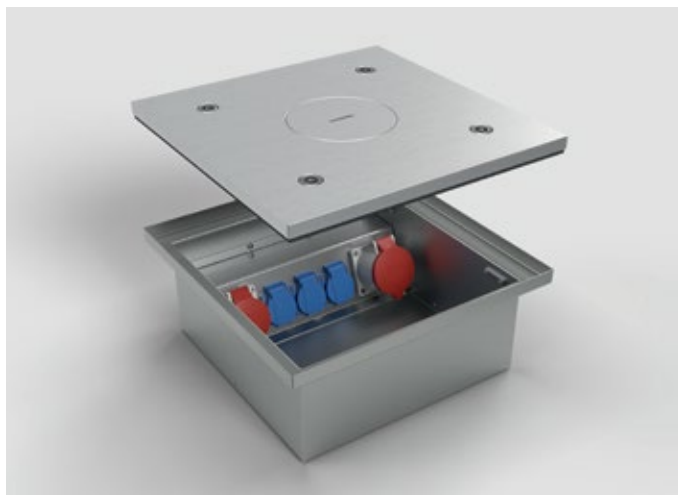

6523Q

Item No.: 6523Q	Equipment: 1x CEE 5/16A 400V/6h, 1x CEE 5/32A 400V/6h, 3x Schuko
Material:	Aluminum, Stainless steel
Dimensions:	400 x 400 x 167 mm
Instl dim:	400 x 400 x 167 mm
Protection:	IP65 (with attached tube IP21)
Load:	Area load max. 900 kg
Supply line:	4x back, each Ø 25/32 mm
Feature:	Lockable with a tool, can be used through the tube with the lid closed.

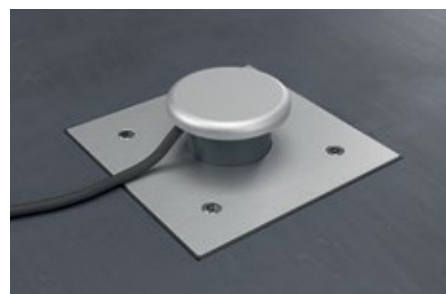

6610A

Item No.: 6610A1 6610A2	Equipment: 1x CEE 5/16A 400V/6h 1x CEE 5/32A 400V/6h
Material:	Stainless steel
Dimensions:	500 x 256 x 210 mm
Instl dim:	500 x 256 x 210 mm
Protection:	IP40
Load:	Area load max. 6500 kg
Supply line:	2x front Ø 25 mm 1x below Drainage opening 50 mm
Feature:	Lockable with tools, can be closed with inserted plugs. When closed, the floor tank is not waterproof. A drainage pipe for drainage of the housing must be connected outdoors. Lid with gas pressure spring.

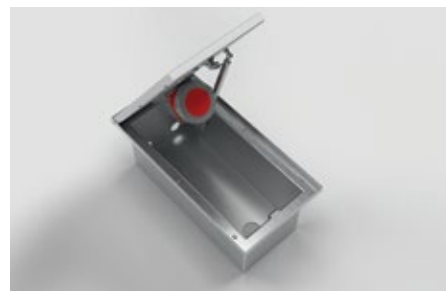



7012A

Item No.:	Equipment:
7012A1	1x CEE 5/16A 400V/6h, 2x Schuko
7012A2	1x CEE 5/32A 400V/6h, 2x Schuko

Material:	Aluminum
Dimensions:	Ø 200 x 150 mm
Instl dim:	Ø 200 x 150 mm
Protection:	IP67
Load:	Area load max. 900 kg
Supply line:	3x below, each Ø 25 mm
Feature:	Lockable with a tool.



7012A63

Item No.:	Equipment:
7012A63	1x CEE 5/63A 400V/6h

Material:	Aluminum
Dimensions:	Ø 200 x 221 mm
Instl dim:	Ø 200 x 221 mm
Protection:	IP67
Load:	Area load max. 900 kg
Supply line:	1x below, each Ø 50 mm
Feature:	Lockable with a tool.





7022A

Item No.:	Equipment:
7022A	1x CEE 5/16A 400V/6h, 1x CEE 5/32A 400V/6h, 2x Schuko
Material:	Aluminum
Dimensions:	Ø 250 x 152 mm
Instl dim:	Ø 250 x 152 mm
Protection:	IP67
Load:	Area load max. 900 kg
Supply line:	3x below, 2x lateral, each Ø 25 mm
Feature:	Lockable with a special key.

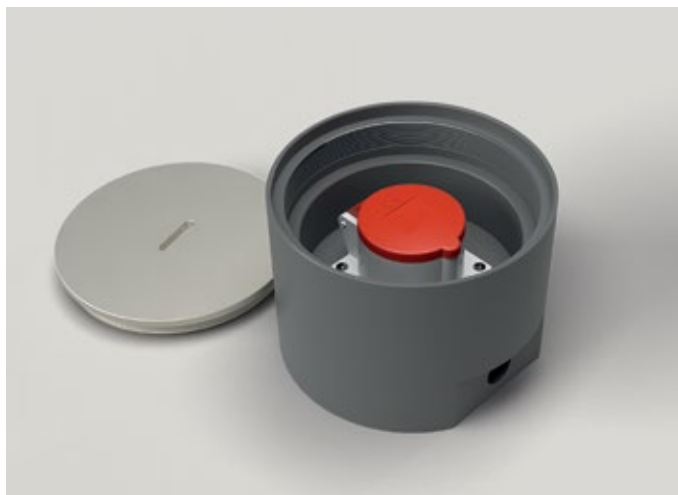

7705A

Item No.:	Equipment:
7705A1	1x CEE 5/16A 400V/6h
7705A2	1x CEE 5/32A 400V/6h
Material:	PVC, Aluminum
Dimensions:	Ø 170 x 120 mm
Instl dim:	Ø 170 x 120 mm
Protection:	IP67
Load:	Area load max. 200 kg
Supply line:	2x lateral, each M25 x 1,5
Feature:	Lockable with a special key.





8310A

Item No.:	Equipment:
8310A1	1x CEE 5/16A 400V/6h
8310A2	1x CEE 5/32A 400V/6h

Material:	Aluminum
Dimensions:	140 x 140 x 132 mm
Instl dim:	140 x 140 x 132 mm
Protection:	IP64
Load:	Area load max. 900 kg
Supply line:	2x back, each Ø 25 mm
Feature:	Lockable without tools.

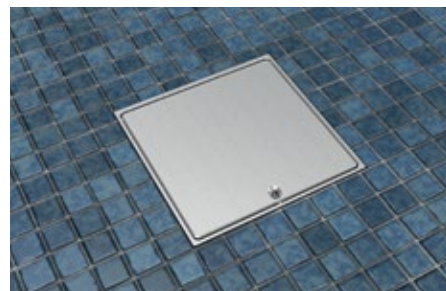

8314A

Item No.:	Equipment:
8314A1	1x CEE 5/16A 400V/6h, 2x Schuko, 2x RJ45 double
8314A2	1x CEE 5/32A 400V/6h, 2x Schuko, 2x RJ45 double

Material:	Aluminum
Dimensions:	250 x 160 x 132 mm
Instl dim:	250 x 160 x 132 mm
Protection:	IP64
Load:	Area load max. 500 kg
Supply line:	4x back, each Ø 25 mm
Feature:	Lockable without tools.



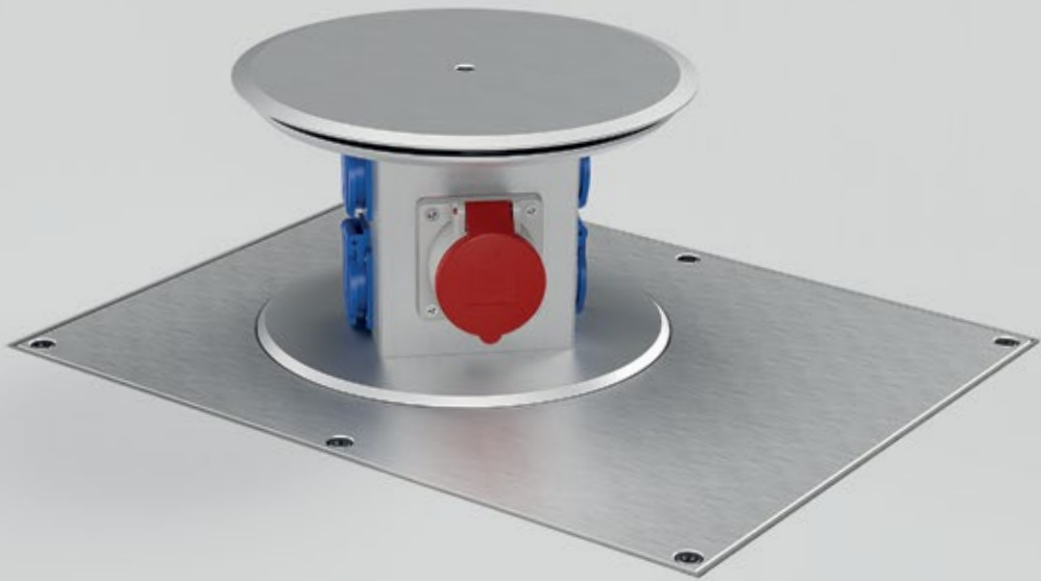

Retractable power distributor



SV111

Equipment:
1 x Schuko

Material: Aluminum, PVC

Dimensions: Ø 106 x 152 mm

Instl dim: 145 x 145 x 152 mm

Protection: IP67

Load: Area load max. 2 tt

Supply line: 1x lateral Ø 25 mm, 1x below Ø 32 mm

Frame design: round

Feature: Salt water resistant, waterproof when closed and opened. The devices are raised and lowered using a special key.



SV112

Equipment:
1 x Schuko

Material: Aluminum, PVC

Dimensions: 125 x 125 x 152 mm

Instl dim: 145 x 145 x 152 mm

Protection: IP67

Load: Area load max. 2 t

Supply line: 1x lateral Ø 25 mm, 1x below Ø 32 mm

Frame design: square

Feature: Salt water resistant, waterproof when closed and opened. The devices are raised and lowered using a special key.

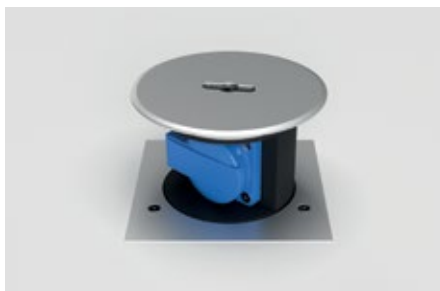



SV301

Item No.:	Equipment:
SV301-2	4x Schuko
SV301-3	1x CEE 5/16A 400V/6h
SV301-4	1x CEE 5/32A 400V/6h
SV301-5	3x Schuko · 1x CEE adapter 16A

Material:	Aluminum, PVC
Dimensions:	Ø 210 x 230 mm
Instl dim:	Ø 210 x 225 mm
Protection:	IP67
Load:	Area load max. 6,5t
Supply line:	1x lateral Ø 25 mm, 1x below Ø 32 mm
Frame design:	round
Feature:	Salt water resistant, waterproof when closed and opened. The devices are raised and lowered using a special key.



SV302

Item No.:	Equipment:
SV302-2	4x Schuko
SV302-3	1x CEE 5/16A 400V/6h
SV302-4	1x CEE 5/32A 400V/6h
SV301-5	3x Schuko · 1x CEE adapter 16A

Material:	Aluminum, PVC
Dimensions:	205 x 205 x 230 mm
Instl dim:	205 x 205 x 225 mm
Protection:	IP67
Load:	Area load max. 6,5t
Supply line:	1x lateral Ø 25 mm, 1x below Ø 32 mm
Frame design:	square
Feature:	Salt water resistant, waterproof when closed and opened. The devices are raised and lowered using a special key.





SV501

Item No.:	Equipment:
SV501-1	8x Schuko
SV501-2	1x CEE 5/16A 400V/6h, 6x Schuko
SV501-3	1x CEE 5/32A 400V/6h, 6x Schuko
SV501-4	1x CEE 5/16A 400V/6h, 1x CEE 5/32A 400V/6h, 4x Schuko

Material:	Aluminum, Stainless steel
Dimensions:	500 x 400 x 251 mm
Instl dim:	500 x 400 x 251 mm
Protection:	IP67
Load:	Area load max. 6,5t
Supply line:	2x lateral, each \varnothing 25 mm / 2x lateral, each \varnothing 32 mm
Feature:	Salt water resistant, waterproof when closed and opened. Raise and lower with a crank.

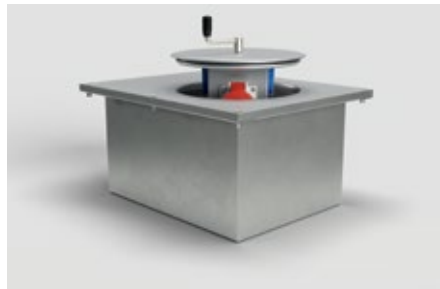



Energy columns



ES301

Item No:	Equipment:
ES301-1	2 x Schuko
ES301-2	1 x Schuko, 1 x switch
ES301-3	1 x Schuko, 1 x USB charge double
ES301-4	1 x Schuko, 1 x RJ45 double

Material:	Stainless steel
Dimensions:	Ø 130 x 230 mm
Base plate:	Ø 130 x 230 mm
Protection:	IP44
Supply line:	2x below, each Ø 25 mm
Weight:	1300 g



ES321

Item No:	Equipment:
ES321-1	2 x Schuko · 2 x CEE 3/16A 230V/6h
ES321-2	2 x Schuko · 1 x CEE 5/16A 400V/6h
ES321-3	4 x Schuko

Parts:	Ground anchor/earth stake (p. 68)
---------------	-----------------------------------

Material:	Stainless steel
Dimensions:	Ø 129 x 438 mm
Base plate:	Ø 180 mm
Protection:	IP44
Supply line:	4x below, each Ø 25 mm
Weight:	4000 g

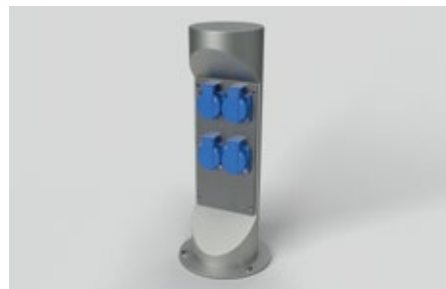



ES323

Item No: ES323-1
ES323-2

Equipment: 1 x CEE 5/16A 400V/6h · 4 x CEE 3/16A 230V/6h
2 x CEE 5/16A 400V/6h · 2 x Schuko

Parts: BAES32 Ground anchor/earth stake (p. 68)

Material: Stainless steel
Dimensions: Ø 154 x 700 mm
Base plate: Ø 210 mm
Protection: IP44
Supply line: from below
Weight: 6500 g



ES325

Equipment: 4 x Schuko · 2 x CEE 5/16A 400V/6h · 2 x CEE 5/32A 400V/6h

Fuse: 4x LS B16 1-pol · 2x LS C16 3-pol · 2x LS C32 3-pol · 1x FI 63A 0,03A 4-pol

Material: Stainless steel
Dimensions: Ø 254 x 1000 mm
Base plate: Ø 320 mm
Protection: IP44
Supply line: from below
Weight: 14 kg

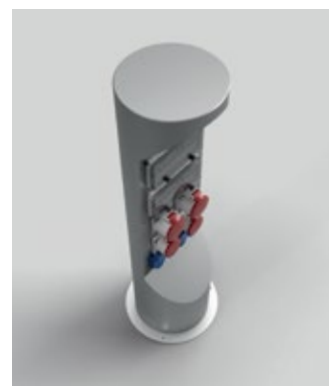



ESP14

Item No.:	Equipment:
ESP14-1	1 x CEE 5/16 A 400V/6h · 4 x Schuko
ESP14-2	1 x CEE 5/32 A 400V/6h · 4 x Schuko
Fuse:	2x LS B16 1-pol · 1 x LS C16 3-pol · 1 x FI 40 A 4-pol 0,03 A

Material:	Stainless steel
Dimensions:	Ø 304 x 1133 mm
Base plate:	Ø 355 mm
Protection:	Housing IP10 / electr. units IP44
Supply line:	from below
Weight:	32 kg
Feature:	Lockable by semi-cylinder. Door can be closed with inserted plugs. The sockets are integrated in the plastic housing, secured with FI/LS and completely wired.

ESP24

Equipment:
1 x CEE 5/32 A · 1 x CEE 5/16 A · 4 x Schuko
Fuse:
2x LS B16 1-pol · 1 x LS C16 3-pol · 1 x LS C32 3-pol · 1 x FI 40 A 0,03 A 4-pol

Material:	Stainless steel
Dimensions:	Ø 356 x 1143 mm
Base plate:	Ø 450 mm
Protection:	Housing IP10 / Distribution box IP44
Supply line:	from below
Weight:	48 kg
Feature:	Lockable by semi-cylinder. Door can be closed with inserted plugs. The sockets are integrated in the plastic housing, secured with FI/LS and completely wired.



EST24

Equipment:

1 x CEE 5/32A · 1 x CEE 5/16A · 4 x Schuko

Fuse:

2 x LS B16 1-pol · 1 x LS C16 3-pol · 1 x LS C32 3-pol · 1 x FI 40A 0,03A 4-pol

Material:

Stainless steel

Dimensions:

421 x 280 x 1000 mm

Protection:

Housing IP10 / Distribution box IP44

Supply line:

from below

Weight:

29 kg

Feature:

Lockable by semi-cylinder. Door can be closed with inserted plugs. The sockets are integrated in the plastic housing, secured with FI/LS and completely wired.

ES401

Item No.:

ES401-1

ES401-2

Equipment:

6 x CEE 3/16A

1 x CEE 5/32A · 1 x CEE 5/16A · 4 x Schuko

Item No.:

ES401-1

ES401-2

Fuse:

6 x FI/LS 2-pol 16 A 0,03 A

1 x LS C32 3-pol · 1 x LS C16 3-pol · 4 x LS B16 1-pol ·

1 x FI 4-pol 63 A 0,03 A

Material:

Stainless steel

Dimensions:

200 x 200 x 1200 mm

Base plate:

230 x 230 mm

Protection:

IP44

Supply line:

from below

Weight:

12,5 kg



ES850

Item No.:	Equipment:
ES850-1	3x Schuko, 1x USB Charge double
ES850-2	3x Schuko, 1x RJ45 double
ES850-3	4x Schuko

Material:	Aluminum (housing), Stainless steel (base plate)
Dimensions:	125 x 125 x 500 mm
Instl dim:	125 x 125 x 500 mm
Protection:	IP20
Supply line:	von below
Weight:	4400 g



OT60A1

Item No.:	Equipment:
OT60A1	2x Schuko, 1x USB Charge double

Parts for: Floor tank 2003Q, 2004Q und 2008Q

Material:	Aluminum
Dimensions:	Ø 79 x 620 mm
Instl dim:	Ø 70 x 600 mm
Protection:	IP20
Supply line:	von below
Weight:	3250 g





BAES32

Item No.:

BAES32 (ground anchor/earth stake)

Parts for:

energy column ES321, ES323 and ES323-EM

Material:

stainless steel

Dimensions:

Ø 210 x 543 mm

Base:

Ø 210 mm

Surface:

sandblasted

Weight:

1,9 kg

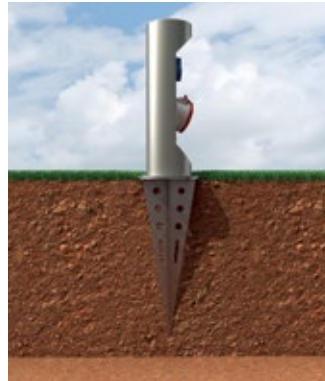

[← Main menu](#)



Wall distributors
Wall sockets



5501A

Item No.:	Equipment:
5501A	1 x Schuko
5501A1	1 x RJ45 double

Material:	Aluminum, Sendzimir galvanized sheet steel
Dimensions:	98x86x60 mm
Instl dim:	95x80x51 mm
Protection:	IP44 (electr. units)
Supply line:	1x front, 2x lateral, 1x back, 2x below, each Ø 25 mm
Weight:	400 g
Feature:	Lockable by rotating latch lock.

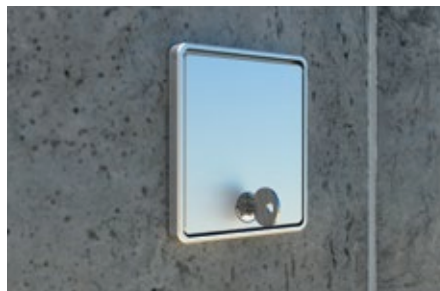

5503A

Item No.:	Equipment:
5503A	3 x Schuko
5503A1	2 x Schuko, 1 x RJ45 double

Material:	Aluminum, Sendzimir galvanized sheet steel
Dimensions:	200 x 200 x 82 mm
Instl dim:	180 x 180 x 80 mm
Protection:	IP44 (electr. units)
Supply line:	2x lateral, 2x back, 2x below, each Ø 25 mm
Weight:	3000 g
Feature:	Ideal for sports halls – audited resistance to ball-impacts (DIN 18032 Part 3). Lockable with tools. Can be closed with inserted plugs.

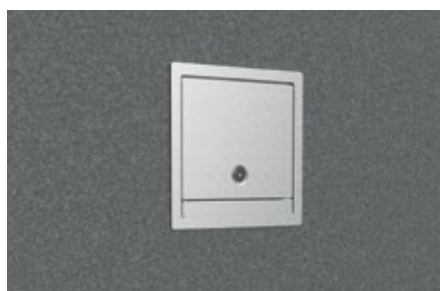



5510E

Item No.:	Equipment:
5510E1	1 x CEE 5/16A 400V/6h
5510E2	1 x CEE 5/32A 400V/6h

Material:	Stainless steel
Dimensions:	320x150x130 mm
Protection:	IP67
Supply line:	Opening on the back 100x100 mm
Weight:	3600 g



5511A

Item No.:	Equipment:
5511A	1 x CEE 5/16A 400V/6h · 1x Schuko

Material:	Aluminum, Sendzimir galvanized sheet steel
Dimensions:	350 x 200 x 103 mm
Instl dim:	337 x 185 x 101 mm
Protection:	IP44 (electr. units)
Supply line:	2x lateral, 2x back, 2x below, each Ø 25 mm
Weight:	4000 g
Feature:	Ideal for sports halls – audited resistance to ball-impacts (DIN 18032 Part 3). Lockable with tools. Can be closed with inserted plugs.

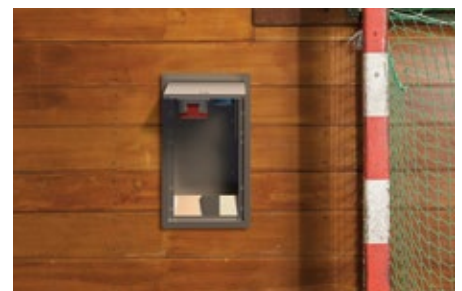



5523A

Item No.: 5523A
Equipment: 3x Schuko · 1x CEE 5/16A 400V/6h · 1x CEE 5/32A 400V/6h

Material: Aluminum, Sendzimir galvanized sheet steel
Dimensions: 400 x 400 x 144 mm
Instl dim: 382 x 383 x 142 mm
Protection: IP44 (electr. units)
Supply line: 2x lateral, 2x back, 2x below, each Ø 25 mm
Weight: 8600 g
Feature: Ideal for sports halls – audited resistance to ball-impacts (DIN 18032 Part 3). Lockable with tools. Can be closed with inserted plugs.



5602E

Item No.: 5602E
Equipment: 2x Schuko

Material: Stainless steel, Aluminum
Dimensions: 103 x 142 x 163 mm
Protection: IP44 (electr. units)
Supply line: 1x above, 1x back, each Ø 25 mm
Weight: 1400 g
Feature: Lockable by rotating latch lock.





5606E

Item No.:	Equipment:
5606E	6 x Schuko
5606E1	3 x Schuko, 3 x FILS

Material:	Stainless steel, Aluminum
Dimensions:	303 x 240 x 157 mm
Protection:	IP44 (electr. units)
Supply line:	2x back, 2x above, 2x below, each Ø 25 mm
Weight:	5100 g
Feature:	The door closes even when standard plugs are inserted and can be locked with a profile half-cylinder lock.



5620E

Item No.:	Equipment:
5602E	1 x CEE 5/16A 400V/6h · 1 x CEE 5/32A 400V/6h

Material:	Stainless steel, Aluminum
Dimensions:	370 x 240 x 167mm
Protection:	IP44 (electr. units)
Supply line:	2x back, 2x above, 2x below, each Ø 25 mm
Weight:	6500 g
Feature:	The door closes even when standard plugs are inserted and can be locked with a profile half-cylinder lock.





5622E

Equipment:

2x Schuko · 1x CEE 5/16A 400V/6h · 1x CEE 5/32A 400V/6h

Fuse:

2x LS B16 1-pol · 1x LS C16 3-pol · 1x LS C32 3-pol · 1x FI 40A 0,03A 4-pol

Material:

Stainless steel, Aluminum

Dimensions:

500x400x218 mm

Protection:

IP44 (electr. units)

Supply line:

2x above, 2x below, each Ø 25 mm

Weight:

13,5kg

Feature:

The door closes even when standard plugs are inserted and can be locked with a profile half-cylinder lock.

5722E

Equipment:

2x Schuko · 1x CEE 5/16A 400V/6h · 1x CEE 5/32A 400V/6h

Fuse:

2x LS B16 1-pol · 1x LS C16 3-pol · 1x LS C32 3-pol · 1x FI 40A 0,03A 4-pol

Material:

Stainless steel, Sendzimir galvanized sheet steel, Aluminum

Dimensions:

498x348x178mm

Instl dim:

450x302x178mm

Protection:

IP44 (electr. units)

Supply line:

2x back, 2x above, Ø 32/40mm

Weight:

13kg

Feature:

The door closes even when standard plugs are inserted and can be locked with a profile half-cylinder lock.



5723E

Equipment:

3x Schuko · 1x CEE 5/16A 400V/6h · 1x CEE 5/32A 400V/6h

Fuse:

3x LS B16 1-pol · 1x LS C16 3-pol · 1x LS C32 3-pol · 1x FI 63A 0,03A 4-pol

Material:

Stainless steel, Sendzimir galvanized sheet steel,
Aluminum

Dimensions:

648 x 448 x 206 mm

Instl dim:

603 x 400 x 205 mm

Protection:

IP44 (electr. units)

Supply line:

5x back, thereof 4x Ø 32 mm / 1x Ø 51 mm

Weight:

17 kg

Feature:

The door closes even when standard plugs are inserted and can be locked with a profile half-cylinder lock.

← Main menu



E-Mobility



5802A

Equipment:

1 x Charging socket Type 2 (IEC 62196) · 2 x Schuko · opt. RFID-Reader

Fuse:

1 x LS B 6A 1-pol · 1 x LS C 32A 3-pol · 1 x FI/LS B 16A 0,03A 1-pol ·
1 x FI 40A 0,03A 4-pol · 1 x Residual current protection > DC 6 mA

Material:

Aluminum, Stainless steel

Dimensions:

551 x 334 x 145 mm

Instl dim:

485 x 304 x 118 mm

Charging power:

3,7–11 kW (optional max. 22 kW)

Charging current:

max. 32 A

Protection:

IP44 (electr. units)

Feature:

Charging Mode 3, 1 to 3-phase charging



5802E

Equipment:

1 x Charging socket Type 2 (IEC 62196) · 2 x Schuko · opt. RFID-Reader

Fuse:

1 x LS B 6A 1-pol · 1 x LS C 32A 3-pol · 1 x FI/LS B 16A 0,03A 1-pol ·
1 x FI 40A 0,03A 4-pol · 1 x Residual current protection > DC 6 mA

Material:

Stainless steel

Dimensions:

496 x 346 x 171 mm

Instl dim:

450 x 302 x 165 mm

Charging power:

3,7–11 kW (optional max. 22 kW)

Charging current:

max. 32 A

Protection:

IP22 (electr. units)

Feature:

Charging Mode 3, 1 to 3-phase charging





ESP24-EM

Equipment:

1x Charging cable Type 2 (IEC 62196) · opt. RFID-Reader · opt. Counter

Fuse:

1x LS B 6A 1-pol · 1x LS C 32A 3-pol · 1x FI 40A 0,03A 4-pol ·
1x Residual current protection > DC 6 mA

Material:

Stainless steel

Dimensions:

Ø 450 (Base), Ø 356 x 1143 mm

Charging power:

3,7–11 kW (optional max. 22 kW)

Charging current:

max. 32 A

Protection:

IP44 (electr. units)

Feature:

Can be closed with inserted plugs. Lockable.



ES323-EM

Equipment:

4 x Schuko

Fuse:

4 x FI/LS 16A 0,03A 2-Pol

Parts:

BAES32 Ground anchor/earth stake (p. 68)

Material:

Stainless steel

Dimensions:

Ø 210 (Fuß), Ø 154 x 700 mm

Weight:

5600 g

Protection:

IP44 (electr. units)

Feature:

Charging points can each be equipped with an energy meter (1-phase).



← Main menu





3202E

Item No.:	Equipment:
3202E	2 x Schuko
3202E1	1 x Schuko, 1 x RJ45 double
3202E2	1 x Schuko, 1 x Aerial
3202E3	1 x Schuko, 1 x USB double Charge

Material:	Stainless steel (1.4301), Sendzimir galvanized sheet steel
Dimensions:	180 x 145 x 82 mm
Instl dim:	166 x 146 x 80 mm
Protection:	IP10
Load:	Area load max. 120kg
Supply line:	2x lateral, 2x back, 2x below, each Ø 25 mm
Feature:	Can be closed with inserted plugs.

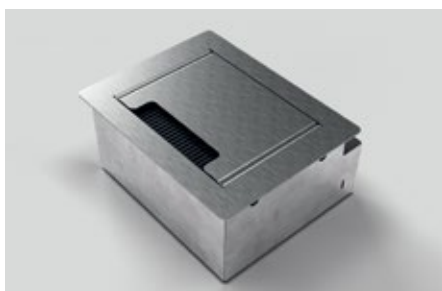

3203E

Item No.:	Equipment:
3203E	3 x Schuko
3203E1	2 x Schuko, 1 x RJ45 double
3203E2	2 x Schuko, 1 x Aerial
3203E3	2 x Schuko, 1 x USB double Charge

Material:	Stainless steel (1.4301), Sendzimir galvanized sheet steel
Dimensions:	230 x 140 x 82 mm
Instl dim:	224 x 145 x 80 mm
Protection:	IP10
Load:	Area load max. 120kg
Supply line:	2x front, 2x back, 2x below, each Ø 25 mm
Feature:	Can be closed with inserted plugs.





OCRH2W

Item No.:	Equipment:
OCRH2W	2 x Schuko
OCRH2W1	1 x Schuko, 1 x RJ45 double
OCRH2W2	1 x Schuko, 1 x USB double Charge
Material:	Shett steel
Dimensions:	173 x 144 x 67 mm
Instl dim:	155 x 127 x 67 mm
Protection:	IP10
Feature:	Can be closed with inserted plugs.



OCRH6W

Item No.:	Equipment:
OCRH6W	6 x Schuko
OCRH6W1	4 x Schuko, 2 x RJ45 double
OCRH6W2	4 x Schuko, 1 x RJ45 double, 1 x Aerial
OCRH6W3	4 x Schuko, 1 x RJ45 double, 1 x USB double Charge
Material:	Sheet steel
Dimensions:	328 x 144 x 67 mm
Instl dim:	307 x 127 x 67 mm
Protection:	IP10
Feature:	Can be closed with inserted plugs.



← Main menu



Hanging distributors



HV1006

Equipment:

3 x Schuko • 1 x CEE 5/16A 400V/6h • 1 x RJ45 double •
1 x Compressed air coupling

Material: Stainless steel (1.4301)

Dimensions: 260x240x150 mm

Protection: IP20

Weight: 2300 g

Supply line: 3x above, each Ø 25 mm

Feature: The hanging distributor HV1006 is delivered with hooks and carabiners (without cables, hoses and wire ropes shown).



[← Main menu](#)



GTC

General Terms and Conditions of sale and delivery of BS Bodensteckdosen Systemtechnik GmbH

I. PRELIMINARY REMARK

1. Area of application

The deliveries, services and offers of BS Bodensteckdosen Systemtechnik GmbH (hereinafter „BS“, „we“, „us“) are made exclusively on the basis of these General Terms and Conditions of Sale and Delivery (hereinafter „GTC“).

These are part of all contracts that we conclude with our customers (hereinafter „customer“, „you“) about the goods we offer.

2. Customer group

- 2.1 Our product range is aimed at both consumers and entrepreneurs.
- 2.2 For the purposes of these Terms and Conditions, (i) a "consumer" is any natural person who concludes a legal transaction for purposes which are predominantly neither commercial nor self-employed (§ 13 BGB) and (ii) an "entrepreneur" is a natural or legal person or a legal partnership that, in concluding a legal transaction, acts in the exercise of its commercial or independent professional activity (§ 14 BGB).

3. Structure

- 3.1 In the following section "II General Conditions", are those conditions listed which apply in particular to consumers.
For entrepreneurs, they also apply, unless it is explicitly stated that the scope is limited to consumers.
- 3.2 In the section "III. Special Conditions "are other conditions listed that apply to business owners only.

II. GENERAL CONDITIONS

1. Contract language

The language available for the contract is German.

2. Contract partner

The contract is concluded with BS Bodensteckdosen Systemtechnik.

3. Offer and conclusion of contract

- 3.1 The offers and prices contained on our website under the domain floor.socketn.com, in brochures, advertisements and other advertising material are non-binding.
- 3.2 If the customer places an order with us, this constitutes a binding offer to conclude a contract within the meaning of § 145 BGB.
The customer is bound by his declaration 10 calendar days after delivery or by order in text form (e.g. by post / fax / e-mail) from the date of dispatch.
We are entitled to accept the offer within this period.
Decisive for the observance of the period is the time, in which our assumption goes to the customer. Acceptance is also the delivery of the ordered goods.
- 3.3 As an alternative to the direct order from the customer, we will gladly provide you with a binding offer in writing (i.S.d. § 145 BGB).
We are bound to this 14 calendar days from dispatch.
The customer is entitled to accept our offer within this period. Decisive for compliance with the deadline is the time of receipt of the acceptance by us. Acceptance is also the payment.

4. Right of withdrawal for Consumers

- 4.1 Every customer who is a consumer is entitled to the statutory right of withdrawal.
Details can be extracted of the cancellation policy, which is printed in our catalog according to these terms and conditions and also on our website under floor.socketn.com and there can be found under the link „Withdrawal“.
- 4.2 The above said under no. 4.1 does not apply to consumers who conclude a contract with us in our business premises (Dingerdisser Str. 36, 33699 Bielefeld) or make a corresponding offer to us. There is no right of withdrawal for these.

The right of withdrawal also does not apply to the following contracts:

- Contracts for the supply of goods that are not prefabricated and of which for the manufacture an individual selection or provision by the consumer is authoritative or which are clearly tailored to the personal needs of the consumer,
- Contracts for the supply of goods, if, due to their character, they were inseparably mixed with other goods after delivery.

5. Return costs upon revocation

In the case that the customer is a consumer and revokes the contract in the context of his legal right of withdrawal, it is agreed that he has to bear the direct costs of returning the goods.

6. Provider identification, summonable address

Our contact details for complaints and other declarations of intent as well as our address are:

BS Bodensteckdosen Systemtechnik GmbH
Dingerdisser Str. 36
33699 Bielefeld
Germany
represented by business executive Viktor Sperle

Telephone: +49 521 9892780
Telefax: +49 521 989278-30

E-mail: info@bodensteckdosen.com

Register court: Amtsgericht Bielefeld
Register number: HRB40648

Sales tax identification number: DE282391374

7. Prices, shipping costs

- 7.1 Our prices include the statutory sales tax.
- 7.2 Shipping is at the expense of the customer.
Regardless of the order value, we charge a flat rate of € 9.00 per order for standard shipping within Germany. For express shipping within Germany, we charge a flat rate of € 40.00 per order, regardless of the order value.
For standard delivery within the EU (except Germany), we charge a flat rate of € 40.00 per order, regardless of the order value. Express shipping to other EU countries is not possible.

8. Payment

Payment is by bank transfer, PayPal or when you buy in our offices in cash.

Payment in advance by bank transfer

When selecting the payment method „bank Transfer“ we will give you our bank details in our offer / order confirmation. There are no additional costs for the customer except for any transaction fees incurred by the customer's bank.

Payment in advance by PayPal

If you select the payment method „PayPal“, we will give you an e-mail address in our offer / order confirmation, which you can use to pay via the aforementioned online provider. In order to be able to use this payment method, the customer must already be registered with PayPal or register first, legitimize himself with his access data and confirm the payment order to us (except, if applicable, guest access).

Technical personnel, drivers and sales force service staff are not eligible for collection.

9. Shipment, Collection

Delivery is only within the EU.

Unless otherwise expressly agreed, we will determine the appropriate shipping method and carrier at our discretion.

In reasonable extent for the customer, we are entitled to partial deliveries. Additional shipping costs are not incurred by the customer through partial deliveries.

In the event of non-availability of the ordered goods due to late or incorrect delivery (including the delivery of small quantities) by our (pre-) supplier in spite of a delivery contract concluded by us with the (pre-) supplier of the ordered goods we reserve the right to not deliver. In this case, we undertake to inform the customer immediately about the unavailability of the ordered goods and to immediately refund any payments already received from the customer.

Delivery takes place within the delivery period specified for the respective product.

The delivery period starts on the day of receipt of the full purchase price (including sales tax and shipping costs).

Delivery is only at ground level and only up to the first door to the address specified by the customer.

If we fail to meet an agreed delivery date, the buyer must set us a reasonable period of grace, which must not be less than one week.

You have the option of picking up at BS Bodensteckdosen Systemtechnik GmbH, Dingerdisser Str. 36, 33699 Bielefeld, Germany for the following business hours:

Mo–Th: 08:00 am – 04:00 pm
Fr: 08:00 am – 02:00 pm

10. Rights in case of material defects

If the customer is a consumer, all goods sold by us are entitled to statutory warranty claims in the event of material defects.

11. Retention of title

The delivered goods remain our property until their complete payment.

12. Privacy

We collect and store the data of the customer necessary for the transaction. When processing the personal data of the customer, we observe the legal provisions. Further details can be found in our „Privacy Policy“, which you will find under the link of the same name on our homepage at floor.socketn.com

13. Sending the contract terms

We provide the customer, who is consumer, at the latest with delivery of the goods, the contract terms including these terms and conditions in writing.

14. Further regulations, dispute resolution

- 14.1 Should one or more provisions of these General Terms and Conditions be invalid, the remainder of the contract remains valid. The ineffective regulation is replaced by the legal regulation.
- 14.2 German law applies excluding the UN sales law (CISG). This choice of law applies only to the extent that this does not withdraw mandatory applicable Consumer protection laws of the state in which the consumer is habitually resident at the time of the order.
- 14.3 The European Commission provides a platform for online dispute resolution (OS), which can be found at the following link: <http://ec.europa.eu/consumers/odr/>. We are not obligated and unwilling to participate in a dispute settlement procedure before a consumer arbitration board.

III. SPECIAL CONDITIONS

1. Future business, Customer-GTC

- 1.1 For customers who are entrepreneurs, these GTC also apply to future business, even if we do not point this out again in the future.
- 1.2 Terms and conditions of the customer do not apply, even if we do not separately contradict their validity in individual cases. Even if we refer to a letter that contains or refers to terms and conditions of the customer or a third party, this does not constitute acceptance of the validity of these terms and conditions.

2. Offer and Conclusion of contract

The statements made in II. 3. regarding the offer and conclusion of the contract also apply to business customers, but with the following provisos:

- 2.1 The sole decisive factor for the legal relationship between us and the customer is the written purchase contract, including these GTC. This completely reproduces all agreements between the contracting parties regarding the subeatcht matter of the contract. Verbal commitments by BS before conclusion of the contract are legally non-binding and verbal agreements of the contracting parties are replaced by the written contract, unless it is expressly clear from them that they continue to be binding.
- 2.2 Information provided by BS on the subeatcht matter of the delivery / service (eg weights, dimensions, utility values, load capacity, tolerances and technical data) as well as our representations of the same (eg drawings and illustrations) are only approximate unless the usability for the contractually provided purpose presupposes an exact match. They are not guaranteed characteristics, but descriptions or labeling of the delivery / service. Customary deviations and deviations, which occur due to legal regulations or represent technical improvements, as well as the replacement of components by equivalent parts are permissible, as far as they do not affect the usability for the contractually intended purpose.
- 2.3 BS reserves the ownership / copyright of all offers and estimates submitted by it, as well as any drawings, illustrations, calculations, brochures, catalogs, models, tools and other documents and aids provided to the customer. The customer may not make these obeamchcts accessible to third parties without the express consent of BS, as such, or in terms of content, notify them, or use or duplicate them themselves or through third parties. He shall, at the request of BS, return these items in full and destroy any copies made if they are no longer required by him in the ordinary course of business or if negotiations do not lead to the conclusion of a contract. Excluded from this is the storage of electronically provided data for the purpose of conventional data backup.

3. Prices, Price changes

The comments made under II. 7 on prices also apply to business customers, but with the following stipulations / changes:

- 3.1 By way of derogation from II.7.1, in the case of tenders and written offers, net prices are given which are understood to be exclusive of statutory value added tax.
- 3.2 Insofar as the agreed prices are based on the list prices of BS and delivery should take place more than four months after the conclusion of the contract, the list prices of BS valid on delivery shall apply.

4. Payment and delay

The comments made under II. 8 on payment options also apply to business customers, but with the following stipulations / changes / additions:

In addition to those in II.8. business customers can also pay by invoice. The invoice amounts are payable within twenty-one days without any deductions, unless otherwise expressly agreed. Decisive for the date of payment is receipt by us. Payment by check is excluded unless it is agreed separately in individual cases.

If the customer does not pay by the due date, the outstanding amounts shall be subeatcht to interest at a rate of 9 percentage points above the base rate from the due date; the assertion of higher interest and further damages in case of default remains unaffected.

5. Set-off and right of retention

- 5.1 The offsetting of counterclaims of the customer or the retention of payments due to such claims is only permitted if the counterclaims are undisputed or legally binding.
- 5.2 BS shall be entitled to execute or render outstanding deliveries or services only against advance payment or provision of security if, after the conclusion of the contract, it becomes aware of circumstances which are capable of substantially reducing the creditworthiness of the customer and by which the payment of BS's outstanding claims of the customer from the respective contractual relationship (including from other individual orders to which the same framework contract applies) is endangered.

6. Shipping, Collection, Place of fulfillment, passing of risk, Approval

By way of derogation from, or supplementary to II. 9., the following applies to business customers with regard to shipping and collection as well as (additionally) with regard to the place of fulfillment, transfer of risk and approval:

- 6.1 Place of fulfillment for all obligations arising from the contractual relationship are our business premises, unless otherwise specified. We reserve the right to deliver goods from other locations (third-party shops). In these cases, the respective location from which the delivery takes place is the place of fulfillment.
- 6.2 The risk shall pass to the customer at the latest upon the handover of the delivery item (whereby the beginning of the loading process is decisive) to the forwarder, carrier or other third party designated for the execution of the shipment. This also applies if partial deliveries are made or BS has taken on other services (such as shipping). If the shipment or transfer is delayed as a result of a made ofe whose made ofe lies with the customer, the risk passes to the customer from the day on which the delivery item is ready for despatch and BS has notified the customer.
- 6.3 Storage costs after transfer of risk shall be borne by the customer. In the case of storage by BS, the storage costs amount to 0.25 percent of the invoice amount of the delivery items to be stored per completed week. The assertion and proof of further or lower storage costs remains reserved.
- 6.4 Deadlines and dates for deliveries and services provided by BS are only approximate, unless a fixed deadline or a fixed date has been expressly confirmed or agreed. If shipment has been agreed, delivery periods and delivery dates refer to the time of transfer to the forwarder, carrier or other third party commissioned with the transport.
- 6.5 Without prejudice to its rights arising from default by the customer, BS may require the customer to extend delivery and service periods or postpone delivery and service deadlines by the period in which the customer fails to meet its contractual obligations towards BS.
- 6.6 BS shall not be liable for impossibility of delivery or for delays in delivery, as far as these are due to force majeure or other unforeseeable events at the time of the conclusion of the contract (eg breakdowns of all kinds, difficulties in material or energy procurement, delays in transport, strikes, legitimate lockouts, lack of manpower, Energy or raw materials, difficulties in obtaining necessary regulatory approvals, regulatory action or the lack of, incorrect or untimely supplier delivery) that BS is not responsible for. If such events make the delivery or service substantially more difficult or impossible and the hindrance is not only temporary, BS is entitled to withdraw from the contract. In the case of obstacles of a temporary duration, the delivery or service periods shall be extended or the delivery or service dates shall be postponed by the period of the hindrance plus a reasonable start-up period. Insofar as the customer can not reasonably be expected to accept the delivery or service as a result of the delay, he can withdraw from the contract by means of an immediate, written declaration to BS.
- 6.7 In reasonable extent for the customer, we are entitled to partial deliveries. Additional shipping costs are not incurred by the customer through partial deliveries.
- 6.8 If BS is in default with a delivery or service or if it becomes impossible for it to deliver or perform any service for whatever reason, BS's liability for damages is limited in accordance with III. 7.
- 6.9 We will insure the shipment against theft, breakage, transport, fire and water damage or other insurable risks only at the express request of the customer and at his expense.
- 6.10 Insofar as acceptance has to take place, the purchased item shall be deemed accepted if
 - the delivery and, if BS also owes the setting up / installation, the setting up / installation is completed,
 - BS informed the customer with reference to the acceptance fiction according to this III. 6.10 and has asked him to accept,
 - 12 working days have passed since the delivery or setting up / installation or the customer has started to use the purchased goods and in this case six working days have elapsed since delivery or installation

and

 - the customer refrained from accepting the goods within this period for any reason other than a defect indicated to us which makes the use of the goods impossible or substantially impaired.

7. Liability

Differing from II. 10., the following applies to liability for business customers under the express application for merchants of § 377 HGB:

- 7.1 We are also liable for damages to customers who are entrepreneurs, according to the legal provisions without limitation, if these
 - a. are based on injury to life, body or health and have been caused by a willful or negligent breach of duty by us, our legal representatives or vicarious agents,

or

 - b. based on an intentional or grossly negligent breach of duty by us, our legal representatives or vicarious agents

or

 - c. based on the product liability law

or

 - d. We have assumed a procurement risk or a guarantee and are therefore liable.
- 7.2 Is a loss based only on negligent but not grossly negligent breach of a contractual obligation (cardinal obligation) by us, our legal representatives or vicarious agents, without at the same time a claim based on the above provisions to a. to d. we are also liable for damages, but limited in amount to Typical and foreseeable damage.

Essential contractual obligations (cardinal obligations) in the above sense are those obligations whose proper fulfillment the customer trusts and may trust, because they shape the contract.
- 7.3 In addition, we are liable, as far as claims for damages are covered by a liability insurance.
- 7.4 It remains with the legal burden of proof distribution.
- 7.5 Further claims for damages against us, our legal representatives or vicarious agents are excluded, no matter on what legal grounds they are based.

8. Statute of limitation of material defects

- 8.1 Rights and claims of customers who are entrepreneurs become statute-barred in one year, unless
 - a. the delivered goods are a thing that has been used for a building in accordance with its normal use and has caused its defectiveness

or

 - b. these are reimbursement claims according to § 479 BGB

or

 - c. the defect is based on an intentional breach of duty by us, our legal representatives or vicarious agents

or

 - d. these are claims for damages.

In cases a. to d. the statutory limitation periods apply.
- 8.2 It remains with the legal provisions on the inhibition, expiry and on the new beginning of the statute of limitations.

9. Retention of title

Differing the provision in II. 11., to customers who are entrepreneurs the following retention of title applies:

- 9.1 We reserve ownership of all delivered goods (goods subeachct to retention of title) until full payment of the purchase price and until such time as all our claims from the business relationship have been paid.
- 9.2 The customer is entitled to process the goods in the ordinary course of business and to resell them, as long as he is not in default with the fulfillment of his obligation towards us or stops his payments. Specifically, the following applies:
- a. The processing or transformation of the reserved goods takes place for us within the meaning of § 950 BGB, without obliging us. By processing or transformation of the reserved goods, the customer does not acquire the property in accordance with § 950 BGB on the new thing.
- If the reserved goods are processed, mixed, blended or combined with other obeamctts, we acquire co-ownership of the new item at a share that corresponds to the ratio of the invoice value of our reserved goods to the total value.
- The provisions applicable to the goods subeachct to retention of title shall apply mutatis mutandis to the co-ownership shares arising under the above provisions.
- b. The customer herewith assigns the receivables from the resale or the other sales transactions, such as Contracts with all ancillary rights to us from and proportionately also in so far as the goods are processed, mixed or blended and we have acquired hereby in the amount of our invoice value co-ownership or the product is permanently installed. Insofar as the reserved goods are processed, mixed, blended or permanently installed, we are entitled to a fraction of the respective claim from the resale in proportion to the invoice value of our reserved goods to the invoice value of the obeamctt.
- If the reserved goods are sold by the customer together with other goods not supplied by us, the customer hereby assigns to us a portion of the claim from the resale in the amount of the invoice value of our reserved goods.
- If the customer has sold this claim in the context of genuine factoring, he hereby assigns to us the claim against the factor which will take its place. If the claim from the resale by the customer into a current account relationship with his customer, he assigns his claim from the current account relationship hereby amounting to the invoice value of the goods subeachct to retention.
- c. We hereby accept the above assignments.
- d. The customer is entitled until the revocation by us to collect the claims assigned to him. The collection authorization expires on revocation, which takes place if the customer is in default of payment or stops the payment. In this case we are authorized by the customer to inform the customers of the assignment and to collect the claim ourselves.
- The customer is obliged to give us on request a detailed list of his claims with the name and address of the customer, amount of each claim, date of invoice, etc. and give us all information and documents necessary for the assertion of the assigned claims and the review to allow this information.
- e. Amounts received from assigned claims by the customer are to be set aside for us until the transfer to us.
- f. Pledges or assignments of security of the reserved goods or the assigned claims are inadmissible. We are to be informed immediately of seizures, stating the seizure creditor.
- 9.3 If the value of the securities to which we are entitled exceeds our total claim against the customer by more than 10%, we shall be obliged to release it at the customer's request.
- 9.4 The customer stores the reserved goods for us free of charge. The customer must insure them against usual dangers such as fire, theft and water to the usual extent. The customer hereby assigns to us his claims for compensation which he is entitled to from damages of the Typee mentioned against insurance companies or other persons liable for compensation in the amount of his claim. We accept the assignment.

10. Place of jurisdiction

- 10.1 The place of jurisdiction is located at our registered office, provided that the entrepreneur's business is a merchant or the other requirements of a jurisdiction agreement according to § 38 ZPO are met.
- 10.2 We are always entitled to use the business customer at his general place of jurisdiction.

11. Proper law

With respect to customers who are entrepreneurs, German law always applies to the contractual relationship, as it does under two contractual partners domiciled in Germany, to the exclusion of the UN Sales Convention (CISG).

Right of Cancellation for Consumers

CANCELLATION POLICY

Right of Cancellation

You have the right to withdraw from this contract within fourteen days without giving any reason.

The revocation period is fourteen days from the day on which you or a third party named by you, who is not the carrier, had or has taken possession of the last goods.

In order to exercise your right of revocation, you must inform us (BS Bodensteckdosen Systemtechnik GmbH, Dingerdisser Str. 36, 33699 Bielefeld, phone: 0521 9892780, fax: 0521 989278-30, E-Mail: info@bodensteckdosen.com) by means of a clear statement (eg one with the post sent letter, fax or e-mail) about your decision to withdraw from this contract.

In order to maintain the cancellation period, it is sufficient for you to send the notification of the exercise of the right of withdrawal before the expiry of the withdrawal period.

Consequences of the cancellation

If you withdraw from this Agreement, we have to repay all payments we have received from you, including delivery charges (except for the additional costs arising from choosing a different delivery method than the most favorable standard delivery we offer) immediately and at the latest within fourteen days from the date on which the notification of your revocation of this contract has reached us. For this repayment, we will use the same means of payment as you used in the original transaction, unless expressly agreed otherwise with you; In no case you will be charged for this repayment fees. We may refuse repayment until we have received the goods back or until you have provided proof that you have returned the goods, whichever is the earlier.

You must return the goods to us immediately and in any event not later than fourteen days from the date on which you inform us of the cancellation of this contract. The deadline is met if you send the goods before the deadline of fourteen days. You bear the immediate costs of returning the goods. You only have to pay for a possible loss in value of the goods, if this loss of value is due to a handling that is not necessary for the examination of the nature, characteristics and functioning of the goods.

End of revocation

The right of withdrawal does not apply to the following contracts:

- Contracts for the supply of goods which are not prefabricated and for the manufacture of which an individual selection or determination by the consumer is decisive or which are clearly tailored to the personal needs of the consumer,
- Contracts for the supply of goods, if, due to their nature, they were inseparably mixed with other goods after delivery.



Retractable power distributor SV302 | Practical outdoors.

Quality, purism and functionality.



BS BODENSTECKDOSEN
SYSTEMTECHNIK

© by BS Bodensteckdosen Systemtechnik GmbH

BS Bodensteckdosen
Systemtechnik GmbH
Dingerdisser Str. 36
33699 Bielefeld, Germany
Fon +49 521 9892780
Fax +49 521 989278-30
info@bodensteckdosen.com
bodensteckdosen.com

Subject to errors and technical changes.